

## FABRICATION OF HAYNES® AND HASTELLOY® SOLID-SOLUTION-STRENGTHENED HIGH-TEMPERATURE ALLOYS

General Guidelines for  
Hot Working, Cold Working,  
Heat Treating, Joining,  
Descaling and Pickling, and  
Finishing.

### Contents

Introduction	3
Hot Working	6
Cold Working	8
Cutting and Shearing	12
Heat Treatment	13
Welding	23
Health and Safety Information	37
Brazing	38
Descaling and Pickling	41
Machining	43
Grinding	48
Appendix I - Cold Work & Anneal Data	49
Appendix II - Typical Specifications	58

# INTRODUCTION

This brochure is a general guide to the fabrication of the solid-solution-strengthened high-temperature alloys produced by Haynes International, Inc. It is not to be considered a detailed instruction manual.

The alloys covered in detail in this guide include:

HAYNES® 25 alloy  
HAYNES 188 alloy  
HAYNES 230® alloy  
HAYNES 556<sup>✱</sup> alloy  
HAYNES alloy 625  
HAYNES HR-120® alloy  
HAYNES HR-160® alloy  
HASTELLOY® S alloy  
HASTELLOY X alloy

Some of the general information provided may be applicable to other HAYNES and HASTELLOY alloy products. Please call a Haynes International Service Center for more information listed on the back cover.

HAYNES® 25 alloy is a cobalt-nickel-chromium-tungsten alloy with excellent high-temperature strength and good oxidation resistance up to about 1800°F (980°C). Alloy 25 also has good resistance to sulfur-bearing environments. It is principally used in aerospace structural parts, for internals in older, established gas turbine engines, and for a variety of industrial applications. The alloy also has good wear resistance, and is used in the cold-worked condition for some bearing and valve applications.

Ask for brochure H-3057

HAYNES® 188 alloy is a cobalt-nickel-chromium-tungsten alloy developed as an upgrade to alloy 25. It combines excellent high-temperature strength with very good oxidation resistance up to about 2000°F (1095°C). Its thermal stability is better than that for alloy 25, and it is easier to fabricate. Alloy 188 also has low cycle fatigue resistance superior to that for most solid-solution-strengthened alloys, and has very good resistance to hot corrosion. It is widely used in both military and civil gas turbine engines and in a variety of industrial applications.

Ask for brochure H-3001

HAYNES® 230® alloy is a nickel-chromium-tungsten-molybdenum alloy that combines excellent high-temperature strength, outstanding oxidation resistance up to about 2100°F (1150°C), premier nitriding resistance, and excellent long-term thermal stability. The 230 alloy also has lower expansion characteristics than most high-temperature alloys, very good low cycle fatigue resistance, and a pronounced resistance to grain coarsening with prolonged exposure at elevated temperatures. Components of 230 alloy are readily fabricated by conventional techniques, and the alloy is castable.

Principal applications for 230 alloy include wrought and cast gas turbine stationary components; aerospace structurals; chemical process and power plant internals; ASME Vessel Code construction; heat treating facility components and fixtures; steam process internals; and many others.

Ask for brochure H-3000

HAYNES® 556<sup>✱</sup> alloy is an iron-nickel-cobalt-chromium alloy with very good high temperature strength and outstanding resistance to a wide range of high-temperature aggressive environments. Developed as an upgrade and direct substitute for MULTIMET® alloy (alloy N-155), 556 alloy has very good oxidation resistance up to 2000°F (1095°C). It has excellent resistance to sulfidizing, carburizing, and chlorine-bearing environments. It is also very resistant to corrosion by molten zinc, and resists molten chloride salts. Components of 556 alloy are easily fabricated by conventional techniques, and the alloy is castable.

Principal applications for 556 alloy include replacement for MULTIMET alloy in gas turbine and aerospace components; internals in waste incinerators, chemical plants, and power plants; hot dip galvanizing and heat treating fixtures; calcining facilities; and ASME Vessel Code construction. It is also an excellent dissimilar filler metal for joining various iron-, nickel-, and cobalt-based high-temperature alloys.

Ask for brochure H-3013

## INTRODUCTION (CON'T.)

HAYNES® 625 alloy is a nickel-chromium-molybdenum-columbium alloy with very good strength up to about 1500°F (815°C) and good oxidation resistance up to about 1800°F (980°C). Although it has relatively poor thermal stability from 1100-1600°F (595-870°C), alloy 625 is widely used for fabricated components in the gas turbine and aerospace industry, in the chemical industry, in the nuclear industry, and in some industrial heating applications. Its good resistance to corrosion in seawater, and to a variety of aqueous corrosive environments, also provides for significant usage in marine and pollution control industry environments. Alloy 625 is readily fabricated, and is used as a dissimilar welding filler metal.

Ask for brochure H-3073

HAYNES® HR-120® alloy is an iron-nickel-chromium alloy with strength significantly superior to common industrial grade iron-nickel-chromium alloys. It has good oxidation resistance up to about 2000°F (1095°C), and is resistant to carburizing and sulfidizing environments. Components of HR-120 alloy are easy to fabricate. Principal applications include heat treating equipment and fixtures, thermal processing equipment, and waste incinerator internals.

Ask for brochure H-3125

HAYNES® HR-160® alloy is a nickel-cobalt-chromium-silicon alloy with outstanding resistance to high-temperature corrosive environments up to about 2200°F (1205°C). It also has good high-temperature strength, and good thermal stability. The resistance of HR-160 alloy to sulfidizing environments, complex waste incineration environments, and environments in many kiln and calciner applications is unmatched by other commercial alloys. It is also well suited for use in many chemical plant and power plant applications. Components of HR-160 alloy are fabricated by conventional techniques.

Ask for brochure H-3129

HASTELLOY® S alloy is a nickel-chromium-molybdenum alloy with outstanding thermal stability combined with moderate strength and very good oxidation resistance up to about 2000°F (1095°C). It also has relatively low thermal expansion characteristics, and is relatively easy to fabricate or cast. Alloy S has been successfully used as a dissimilar filler metal for welding other high-temperature alloys. Principal applications include gas turbine seal rings, casings, and containment structures, as well as some industrial uses.

Ask for brochure H-3003

HASTELLOY® X alloy is a nickel-iron-chromium-molybdenum alloy with good high-temperature strength, very good oxidation resistance to about 2000°F (1095°C), and other fairly well-rounded high-temperature properties. Largely surpassed in capabilities by more recent alloys, it is still one of the most extensively used materials in the gas turbine and aerospace industries. It is also well known in the chemical process and power industries, and is approved for ASME Vessel Code construction. Alloy X is one of the easiest of the solid-solution-strengthened alloys to fabricate.

Ask for brochure H-3009

## NOMINAL CHEMICAL COMPOSITIONS

The following table includes chemical compositions for the solid-solution-strengthened high-temperature alloys which are manufactured by Haynes

International, Inc. Although these materials are not all treated in specific detail in this guide, some of the general information given for specific

alloys may also be relevant to the fabrication of those not specifically mentioned. Please call Haynes International for further information.

TABLE 1 - Composition (Weight %)

Material	Ni	Co	Fe	Cr	Mo	W	Mn	Si	C	Al	La	Others
HAYNES® 6B alloy	2.5	58 <sup>a</sup>	3*	30	1.5*	4	1.4	0.7	1	-	-	-
HAYNES 25 alloy	10	51 <sup>a</sup>	3*	20	-	15	1.5	0.4*	0.10	-	-	-
HAYNES 188 alloy	22	39 <sup>a</sup>	3*	22	-	14	1.25*	0.35	0.10	-	0.03	-
HAYNES 75 alloy	76 <sup>a</sup>	-	5*	20	-	-	1*	1*	0.11	-	-	0.4Ti,0.5Cu*
HAYNES 230® alloy	57 <sup>a</sup>	5*	3*	22	2	14	0.5	0.4	0.10	0.3	0.2	0.015B*
HAYNES 625 alloy	62 <sup>a</sup>	1*	5*	21	9	-	0.5*	0.5*	0.10*	0.4*	-	3.7(Cb+Ta),0.4Ti*
HAYNES HR-160® alloy	37 <sup>a</sup>	29	2	28	1*	1*	0.5	2.75	0.05	-	-	0.5Ti
HASTELLOY® B alloy	67 <sup>a</sup>	2.5*	5	1*	28	-	1*	1*	0.05*	-	-	0.3V,0.5Cu*
HASTELLOY S alloy	67 <sup>a</sup>	2*	3*	16	15	1*	0.5	0.4	0.02*	0.25	0.02	0.015B*
HASTELLOY W alloy	63 <sup>a</sup>	2.5*	6	5	24	-	1*	1*	0.12*	-	-	0.6V*
HASTELLOY X alloy	47 <sup>a</sup>	1.5	18	22	9	0.6	1*	1*	0.10	-	-	0.008B*
HAYNES HR-120® alloy	37	3*	33 <sup>a</sup>	25	2.5*	2.5*	0.7	0.6	0.05	0.1	-	0.7Cb,0.2N,0.004B
MULTIMET® alloy	20	20	30 <sup>a</sup>	21	3	2.5	1.5	1*	0.12	-	-	1(Cb+Ta), 0.15N
HAYNES 556 alloy	20	18	31 <sup>a</sup>	22	3	2.5	1	0.4	0.10	0.2	0.02	0.6Ta,0.2N,0.02Zr

<sup>a</sup> As balance

\*Maximum

## HOT WORKING

HAYNES® and HASTELLOY® high-temperature alloys may be hot worked into various forms; however, these alloys can be more sensitive to the amount and rate of hot reduction than is typical for austenitic stainless steels. In addition, the hot working temperature ranges for these alloys can be narrow. Particular care must be exercised during hot working in order to achieve satisfactory results.

The characteristics of solid-solution-strengthened high-temperature alloys which must be considered in developing a particular hot working practice include (1) relatively low melting temperatures; (2) high hot strength; (3) rapid work hardening; and (4) relatively low thermal conductivity. Furthermore, the resistance to deformation in these alloys may increase rapidly as temperature

falls to the low end of the hot working range. Accordingly, hot working practices which incorporate heavy initial and moderate final reductions, coupled with frequent reheating, often yield the best results. In addition, slow deformation rates tend to minimize adiabatic heating and applied force requirements.

## FORGING

The following are general rules to follow in forging these alloys:

- Soak billets or ingots at least 1/2 hour at forging temperature for each inch (25 mm) of thickness. The use of a well-calibrated optical pyrometer is essential.
- The stock should be turned frequently to present the cooler side to the furnace atmosphere. Direct flame impingement on the alloy must be avoided.
- Forging should begin immediately after withdrawal from the furnace. A short time lapse may allow surface temperature to drop as much as 100 to 200°F (38 to 93°C). Do not raise the forging temperature to compensate for heat loss, as this may cause incipient melting.
- Moderately heavy reductions (25 to 40 percent) are beneficial to maintain as much internal heat as possible, thus minimizing grain coarsening and the number of reheatings. Reductions greater than 40 percent per session should be avoided.
- Care must be taken to impart sufficient hot work during forging to ensure that appropriate structure and properties are achieved in the final part. For parts with large cross sections, it is advisable to include a number of forging upsets in the hot working schedule to allow for adequate forging reductions. Upset L/D ratios of 3:1 are generally acceptable.
- Light-reduction finish sizing sessions should generally be avoided. If required, they should be performed at the lower end of the forging temperature range.
- Do not make radical changes in the cross sectional shape, such as going from a square directly to a round, during initial forming stages. Instead, go from square to round-cornered-square to octagon to round.
- Condition out any cracks or tears developed during forging. Very often this can be done at intermediate stages between forging sessions.

The hot working temperature ranges recommended for HAYNES and HASTELLOY high-temperature alloys are given in Table 2.

## HOT ROLLING

Hot rolling of HAYNES® and HASTELLOY® high-temperature alloys is readily accomplished for a variety of conventional rolled forms, including bars, rings and flats. The basic considerations are similar to those for forging. Reductions of 15 to 20 percent per pass are usually acceptable.

The total reduction per session should generally be at least 20 to 30 percent, particularly for the final session. Finishing in the lower end of the hot working temperature range is usually desirable to produce the best structure and properties.

Frequent reheating during hot rolling may be required to keep the temperature of the work

piece in the hot working range. Care should be taken to ensure that the work piece is thoroughly soaked at the hot working temperature before rolling.

The hot working temperature ranges recommended for HAYNES and HASTELLOY high-temperature alloys are given in Table 2.

TABLE 2 - Recommended Hot Working Temperature Ranges

Material	Furnace Temperature*		Minimum Temperature**	
	°F	°C	°F	°C
HAYNES 25 alloy	2250	1230	1850	1010
HAYNES 188 alloy	2150	1175	1800	980
HAYNES 230® alloy	2200	1205	1800	980
HAYNES 556 alloy	2150	1175	1750	955
HAYNES 625 alloy	2150	1175	1800	980
HAYNES HR-120® alloy	2125	1165	1750	955
HAYNES HR-160® alloy	2050	1120	1750	955
HASTELLOY S alloy	2150	1175	1750	955
HASTELLOY X alloy	2150	1175	1750	955

\*Maximum

\*\*Depending upon the nature and degree of working

## OTHER HOT WORKING TECHNIQUES

HAYNES and HASTELLOY high-temperature alloys may be hot worked by a number of additional techniques, including

extrusion, hot spinning, and others. The parameters for such operations are specific to the exact nature of the work

being done. Please contact Haynes International for more information.

# COLD WORKING

HAYNES® and HASTELLOY® high-temperature alloys may be readily formed into various configurations by cold working. Since they are generally stronger, and work harden more rapidly than austenitic stainless steels, the application of greater force is normally required to achieve the same amount of cold deformation. The higher yield strength of these alloys may also result in greater spring back during cold forming than seen for stainless steels. Furthermore, the rapid work hardening characteristics of these alloys may necessitate more frequent intermediate annealing between forming steps to make a finished part.

The effect of cold work upon the room temperature hardness of various alloys is shown in Figure 1. Results to be expected for a typical austenitic stainless steel are included for comparison. The rapid development of high hardness levels with imposed cold work is clearly evident, particularly for the cobalt-based alloys 25 and 188. More detailed data on the hardness response to imposed cold work, together with corresponding

Figure 1  
Effect of Cold Work Upon Hardness

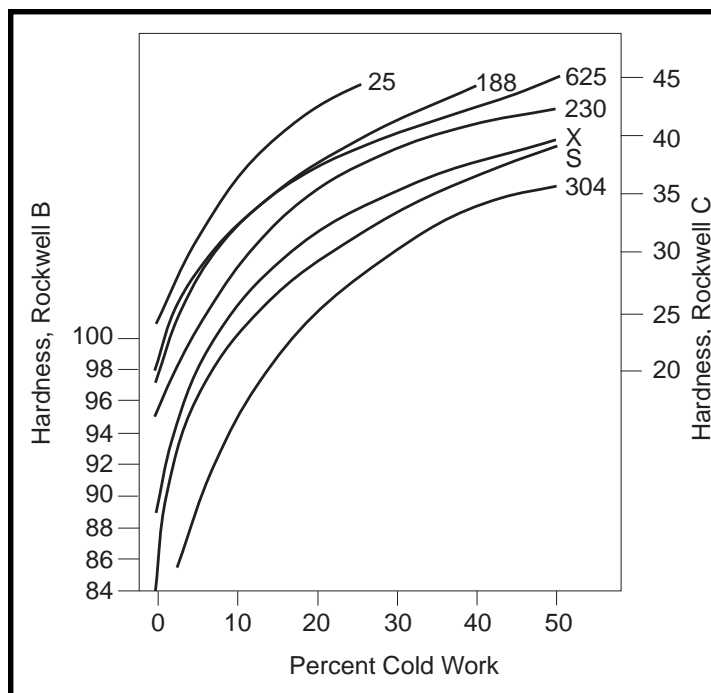

tensile properties, are given in Table 3. While not definitive for determining the extent to which a given forming operation can be performed before annealing is required, this data can be useful in formulating forming limits based upon relative behavior.

TABLE 3a - Hardness After Imposed Cold Work\*

Material	0%	10%	15%	20%	25%	30%	40%	50%
HAYNES 25 alloy	24Rc	36Rc	40Rc	42Rc	44Rc	-	-	-
HAYNES 188 alloy	98Rb	32Rc	-	37Rc	-	41Rc	44Rc	-
HAYNES 230® alloy	95Rb	28Rc	-	35Rc	-	39Rc	40Rc	42Rc
HAYNES 556 <sup>a</sup> alloy	88Rb	25Rc	-	32Rc	-	39Rc	41Rc	42Rc
HAYNES 625 alloy	97Rb	32Rc	-	37Rc	-	40Rc	42Rc	45Rc
HAYNES HR-120® alloy	93Rb	27Rc	-	32Rc	-	34Rc	35Rc	36Rc
HAYNES HR-160® alloy	88Rb	21Rc	-	30Rc	-	35Rc	39Rc	41Rc
HASTELLOY S alloy	84Rb	23Rc	-	29Rc	-	33Rc	36Rc	39Rc
HASTELLOY X alloy	89Rb	25Rc	-	31Rc	-	35Rc	37Rc	39Rc

\*Rb = Rockwell B; Rc = Rockwell C

<sup>a</sup>12%    <sup>b</sup>24%    <sup>c</sup>42%

## COLD WORKING (CON'T.)

TABLE 3b - Yield Strength After Imposed Cold Work (Ksi)\*

Material	0%	10%	15%	20%	25%	30%	40%	50%
HAYNES® 25 alloy	68	124	149	151	184	-	-	-
HAYNES 188 alloy	67	106	-	133	-	167	177	-
HAYNES 230® alloy	62	104	-	134	-	160	173	185
HAYNES 556 alloy	53	93	-	113	-	144	156	170
HAYNES 625 alloy	70	113	-	140	-	162	178	193
HAYNES HR-120® alloy	60	103	-	129	-	143	159	166
HAYNES HR-160® alloy	50	81	-	112	-	145	164	174
HASTELLOY® S alloy	74	92	-	136	-	154	166	177
HASTELLOY X alloy	57	96	-	122	-	142	159	171

\*To convert to MPa multiply by 6.895

TABLE 3c - Tensile Elongation After Imposed Cold Work (%)

Material	0%	10%	15%	20%	25%	30%	40%	50%
HAYNES 25 alloy	58	37	28	18	15	-	-	-
HAYNES 188 alloy	54	45	-	28	-	13	10	-
HAYNES 230 alloy	47	32	-	17	-	10	8	6
HAYNES 556 alloy	51	35	-	24	-	12	10	8
HAYNES 625 alloy	46	31	-	16	-	11	8	5
HAYNES HR-120 alloy	39	26	-	11	-	6	6	5
HAYNES HR-160 alloy	68	52	-	28	-	13	9	8
HASTELLOY S alloy	45	38	-	17	-	10	9	7
HASTELLOY X alloy	46	29	-	15	-	10	8	8



## COLD WORKING (CON'T.)

To produce satisfactory parts, the condition of the material must be closely monitored throughout the forming operation. Material is normally supplied in the solution-annealed or mill-annealed condition, and is generally suitable for mild to moderate forming as-received. Each successive operation should be followed by an intermediate anneal to restore ductility. Intermediate annealing should be performed in accordance with the recommendations given in the HEAT TREATMENT section of this guide.

Lubrication is a significant consideration for successfully cold working these alloys. Although lubrication is seldom required for a simple bending operation, for example, the use of lubricants may be essential for other forming operations, such as cold drawing. Mild forming operations can be successfully completed by using lard oil or castor oil, which are easily removed. More severe forming operations require metallic soaps or chlorinated or sulfochlorinated oils.

CAUTION: When the sulfochlorinated oils are used, the work-piece must be carefully cleaned in a degreaser or alkaline cleaner.

Lubricants that contain white lead, zinc compounds, or molybdenum disulfide are **not recommended** because they are difficult to remove prior to the final anneal. Also lead, zinc, and sulfur can severely embrittle these alloys. Care should be taken to remove die material, lubricants, or other foreign materials from the part before annealing as many of these preparations will affect the properties of the alloys.

## BENDING, ROLL-FORMING, ROLL-BENDING, PRESS-BRAKING

HAYNES® and HASTELLOY® high-temperature sheet and plate materials are readily formed by simple bending, roll-forming, roll-bending, and press-braking operations. Lubrication is generally not required. General minimum bend radius guidelines are given in Table 4, but may vary in applicability from alloy to alloy. Heavy section thickness bends may require multiple steps to accomplish. Intermediate annealing required in such cases should be performed in accordance with the recommendations given in the HEAT TREATMENT section of this guide.

TABLE 4

Material Thickness		Suggested Minimum Bend Radius*
in.	mm	
<0.050	<1.27	1 T
0.050-0.187	1.27 - 4.75	1.5 T
0.188-0.500	4.76 - 12.70	2 T
0.501-0.750	12.71 - 19.05	3 T
0.751-1.000	19.06 - 25.40	4 T

\* T = Material Thickness

## DEEP DRAWING, STRETCH FORMING, HYDROFORMING

HAYNES and HASTELLOY high-temperature alloys may be formed by deep drawing, stretch forming, hydroforming, and other similar operations. Lubrication is generally required. Specially produced

fine-grain-size starting material may provide superior performance in these types of forming operations. Heavy section thickness parts may require multiple forming steps, accompanied by appropriate interme-

mediate anneals as given in the HEAT TREATMENT section of this guide.

Comparative standard Olsen cup test results (lubricated) for these alloys are given in Table 5 for reference.

## COLD WORKING (CON'T.)

TABLE 5

Material	Average Olsen Cup Depth*	
	in.	mm
HAYNES 25 alloy	0.443	11.3
HAYNES® 188 alloy	0.490	12.4
HAYNES 230® alloy	0.460	11.7
HAYNES 556® alloy	0.480	12.2
HAYNES 625 alloy	0.440	11.2
HASTELLOY® S alloy	0.513	13.0
HASTELLOY X alloy	0.484	12.3
Type 310 Stainless	0.505	12.8

\*Average of 3 to 12 measurements on 0.040 to 0.070" (1.0 to 1.75 mm) thick sheet

## SPINNING AND SHEAR SPINNING

Spinning is a deformation process for forming sheet metal or tubing into seamless hollow cylinders, cone hemispheres, or other symmetrical circular shapes by a combination of rotation and force. There are two basic forms known as manual spinning and power or shear spinning. In the former method no appreciable thinning of metal occurs, whereas in the latter, metal is thinned as a result of shear forces.

Nearly all HAYNES and HASTELLOY high-temperature alloys can be spin formed, generally at room temperature. The control of quality, including freedom from wrinkles and scratches as well as dimensional accuracy, is largely dependent upon operator skill. The primary parameters that should be considered when spinning these alloys are:

- Speed
- Feed Rate

- Lubrication
- Material
- Strain Hardening Characteristics
- Tool Material, Design, and Surface Finish
- Power of the Machine

Optimum combinations of speed, feed, and pressure normally should be determined experimentally when a "new job" is set up. During continuous operation, changes in the temperature of the mandrel and spinning tool may necessitate the adjustment of pressure, speed, and feed to obtain uniform results.

Lubrication should be used in all spinning operations. The usual practice is to apply lubricant to the blank prior to loading in the machine. It may be necessary to add lubricants during operation. During spinning, the work piece and tools should be flooded with a coolant such as an emulsion of

soluble oil in water. CAUTION: Sulfurized or chlorinated lubricants should not be used since the operation of spinning may burnish the lubricant into the surface. If these lubricants are used, the parts should be aggressively cleaned, (ground, polished or pickled) prior to any intermediate or final annealing operations.

The tool material, work piece design, and surface finish are all very important in achieving trouble-free operation. Mandrels used in spinning must be hard, wear resistant, and resistant to the fatigue resulting from normal eccentric loading.

As is the case for other cold forming operations, parts produced by cold spinning should be intermediate and final annealed in accordance with the HEAT TREATMENT section of this guide.

## COLD WORKING (CON'T.)

### TUBE FORMING

HAYNES® and HASTELLOY® high-temperature alloys can readily be formed cold in standard pipe and tube bending equipment. The minimum recommended bending radius from the radius point to the centerline of the tube is three times the tube diameter for most bending operations. When measured from centerline to centerline of the "hairpin" straight legs, it is six times the tube diameter (see Figure 2).

For some combinations of tube diameter and wall thickness, the minimum bending radius can be reduced to twice the tube diameter.

As the ratio of tube diameter to wall thickness increases, the need for internal and external support becomes increasingly important in order to prevent distortion. If too small a bending radius is used, wrinkles, poor ovality, and buckling can occur in addition to wall thinning.

Figure 2  
Minimum Bending Radius

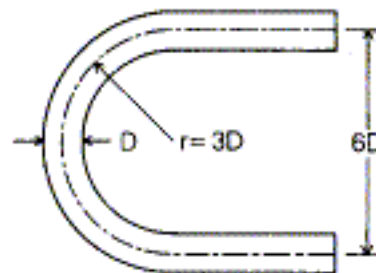

r = Minimum Bending Radius  
D = Tube Diameter

### PUNCHING

Punching is usually performed cold. Perforation should be limited to a minimum diameter of twice the gage thickness. The center-to-center dimension should be approximately three to four times the hole diameters.

Punch to Die Clearances per side

Punch to Die Clearances per side	
Annealed Sheet up to 0.125" (3.2 mm)	3-5% of Thickness
Annealed Sheet or Plate over 0.125" (3.2 mm)	5-10% of Thickness

### CUTTING AND SHEARING

In view of the higher hardness and more rapid work hardening characteristics of these alloys in comparison to carbon steels and austenitic stainless steels, use of band saw cutting techniques are generally not recommended. For flat products, shearing may be successfully performed on scissor type shears rated for carbon steel thicknesses at least 50 percent above the alloy thickness involved. Generally, alloy thicknesses up to 0.4375 inch (11.1 mm) are shearable, while thicker material is normally cut by abrasive saw or plasma arc

cutting. Abrasive water jet and laser cutting of flat sheet and plate are also permissible. Bar and tubular products are normally abrasive saw cut.

Abrasive cutting can be successfully performed using aluminum oxide resin-bonded abrasive wheels. A typical grain and grade designation would be 86A361-LB25W EXC-E.

HAYNES and HASTELLOY high-temperature alloys can be plasma arc cut using any conventional system. The best

arc quality is achieved using a mixture of argon and hydrogen gases. Nitrogen gas can be substituted for hydrogen, but the cut quality will not be quite as good. Shop air or oxygen-containing gases should be avoided when plasma cutting these alloys.

Oxy-Acetylene cutting of these alloys is not recommended. Air carbon arc cutting is feasible, but subsequent grinding to remove carbon contamination is likely to be required.

# HEAT TREATMENT

Solid-solution-strengthened HAYNES® and HASTELLOY® high-temperature alloys are normally supplied in the solution-heat-treated condition, unless otherwise specified. In this condition, microstructures generally consist of primary carbides dispersed in a single phase matrix, with essentially clean grain boundaries. This is usually the optimum condition for the best elevated temperature properties in service, and the best room temperature fabricability. Typical solution heat treatment temperature ranges for these alloys are given in Table 6.

Heat treatments performed at temperatures below the solution heat treating temperature range are classified as mill annealing or stress relief treatments. Mill annealing treatments are generally employed for the purpose of restoring formed, partially fabricated, or otherwise as-worked alloy material

properties to a point where continued manufacturing operations can be performed. Such treatments may also be used to produce structures in finished raw materials which are optimum for specific forming operations, such as fine grain size for deep drawing applications; to produce structures in finished components which are optimized for some specific performance characteristic; or to otherwise deal with external constraints, such as avoidance of component distortion at full solution annealing temperatures.

Minimum recommended mill annealing temperatures for these alloys are given in Table 6. It must be recognized that the use of a mill annealing heat treatment will usually result in the precipitation of secondary carbides on grain boundaries of material originally supplied in the solution-annealed condition, and will not normally restore the material to the as-received

condition. The suitability of a particular mill annealing treatment in lieu of a full solution heat treatment during forming and fabrication will depend upon the nature of the specific operations being performed.

Unlike mill annealing, stress relief treatments for these alloys are not well defined. Depending upon the particular circumstances, stress relief may be achieved with a mill anneal, or may require the equivalent of a full solution anneal. Low temperature treatments, which work for carbon and stainless steels, generally will not be effective. Effective high temperature treatments will often be a compromise between how much stress is actually relieved, and concurrent changes in the structure or dimensional stability of the component.

TABLE 6

Material	Typical Solution Annealing Temperatures		Minimum Mill Annealing Temperature	
	°F	°C	°F	°C
HAYNES 25 alloy	2150-2250	1175-1230	2050	1120
HAYNES 188 alloy	2125-2175	1165-1190	2050	1120
HAYNES 230® alloy	2125-2275	1165-1245	2050	1120
HAYNES 556 alloy	2125-2175	1165-1190	1900	1035
HAYNES 625 alloy	2000-2200	1095-1205	1700	925
HAYNES HR-120® alloy	2150-2250	1175-1230	1950	1065
HAYNES HR-160® alloy	2025-2075	1107-1135	1950	1065
HASTELLOY S alloy	1925-2075	1050-1135	1750	955
HASTELLOY X alloy	2125-2175	1165-1190	1850	1010

## HEAT TREATMENT (CON'T.)

### ANNEALING DURING COLD OR WARM FORMING

The response of HAYNES® and HASTELLOY® high-temperature alloys to heat treatment is very much dependent upon the condition that the material is in when the treatment is applied. When the material is not in a cold- or warm-worked condition, the principal response to heat treatment is usually a change in the amount and morphology of the secondary carbide phases present. Other minor effects may occur, but the grain structure of the material will normally be unaltered by heat treatment when cold or warm work is absent.

When the material is in the cold- or warm-worked condition, application of a mill anneal or solution heat treatment (as defined on page 13) will almost always alter the grain structure of the component. The amount of prior cold or warm work in the piece will significantly influence the resulting grain structure and mechanical characteristics of the material. The results for several combinations of prior cold work and annealing temperature upon the grain

structure response for sheet product of various alloys are given in Table 7. More extensive results for room temperature hardness, yield strength, and tensile elongation are illustrated in Figures 3 to 5, and detailed in Appendix I. All of these results were used to formulate the minimum mill annealing temperatures given in Table 6.

The particular sequence of cold work or warm work/annealing cycles used in multi-step component forming can also have an effect upon the structure and properties of these alloys. One general guideline of particular importance is to keep the temperatures used for intermediate annealing steps at or below the final annealing temperature. Intermediate annealing at temperatures above the final annealing temperature will reduce the degree of structure control possible in the component.

Care should be exercised in cold forming these alloys to avoid the imposition of less

than 10 percent cold work where possible. Small amounts of cold work can lead to exaggerated or abnormal grain growth during annealing. The sensitivity to this phenomenon varies from alloy to alloy, and is dependent upon annealing temperature, as shown in Table 8. In the everyday fabrication of complex components, it may be impossible to avoid situations where such low levels of cold work or strain are introduced. Procedures which may be effective for minimizing the problem are:

- Solution heat treating at the low end of the allowable temperature ranges
- Utilizing mill anneals in preference to solution anneals for intermediate heat treatments during component forming
- Performing a mill anneal directly prior to a final solution anneal on a component.

TABLE 7

Cold Work %	Anneal Temperature* °F (°C)	ASTM Grain Size Produced**			
		HAYNES 25 alloy	HAYNES 230® alloy	HAYNES 556™ alloy	HASTELLOY X alloy
0	None	3 1/2 - 4	5 - 6	5 - 6	4 - 5
10	1850 (1010)	N/A	N/A	NR	NR
	1950 (1065)	NR	NR	NR	NR
	2050 (1120)	NR	NFR	5 - 5 1/2	5 - 7
	2150 (1175)	4 - 4 1/2	4 - 7	5 - 5 1/2	N/A
	2250 (1230)	3 - 4 1/2	6 1/2 - 7	N/A	N/A

# HEAT TREATMENT (CON'T.)

TABLE 7 (Con't.)

Cold Work %	Anneal Temperature* °F (°C)	ASTM Grain Size Produced**			
		HAYNES 25 alloy	HAYNES 230® alloy	HAYNES 556™ alloy	HASTELLOY X alloy
15	1950 (1065)	7	N/A	N/A	N/A
	2050 (1120)	6 - 7	N/A	N/A	N/A
	2150 (1175)	5 - 7	N/A	N/A	N/A
	2250 (1230)	3 - 4 1/2	N/A	N/A	N/A
20	1850 (1010)	N/A	N/A	NR	NFR
	1950 (1065)	7 - 8	NFR	NR	NFR
	2050 (1120)	7 - 8	8 - 8 1/2	7 1/2 - 8 1/2	7 - 8
	2150 (1175)	4 1/2 - 7	7 1/2 - 8	6 - 6 1/2	N/A
	2250 (1230)	2 1/2 - 4 1/2	7 - 7 1/2	N/A	N/A
25	1950 (1065)	7 1/2 - 8	N/A	N/A	N/A
	2050 (1120)	7 1/2 - 8	N/A	N/A	N/A
	2150 (1175)	4	N/A	N/A	N/A
	2250 (1230)	3 1/2	N/A	N/A	N/A
30	1850 (1010)	N/A	N/A	NFR	NFR
	1950 (1065)	N/A	8 - 9	7 1/2 - 9 1/2	8 - 10
	2050 (1120)	N/A	9 - 10	7 - 7 1/2	7 1/2 - 9 1/2
	2150 (1175)	N/A	8 1/2 - 9	4 1/2 - 6 1/2	N/A
	2250 (1230)	N/A	6 - 7	N/A	N/A
40	1850 (1010)	N/A	N/A	7 1/2 - 9 1/2	8 - 9
	1950 (1065)	N/A	9 1/2 - 10	8 - 9 1/2	8 - 10
	2050 (1120)	N/A	9 - 10	7 - 9	9 1/2 - 10
	2150 (1175)	N/A	8 1/2 - 9	4 1/2 - 6 1/2	N/A
	2250 (1230)	N/A	4 - 7	N/A	N/A
50	1850 (1010)	N/A	N/A	9 - 10	8 1/2 - 10
	1950 (1065)	N/A	9 - 10	8 1/2 - 10	8 1/2 - 10
	2050 (1120)	N/A	9 - 10	8 - 9 1/2	8 1/2 - 10
	2150 (1175)	N/A	9 - 9 1/2	5 1/2 - 6	N/A
	2250 (1230)	N/A	5 1/2 - 6 1/2	N/A	N/A

\*5 minutes \*\* N/A = Not Available; NR = No Recrystallization Observed; NFR = Not Fully Recrystallized

# HEAT TREATMENT (CON'T.)

Figure 3  
Effect of Anneal Temperature Upon Hardness of Cold-Worked Material

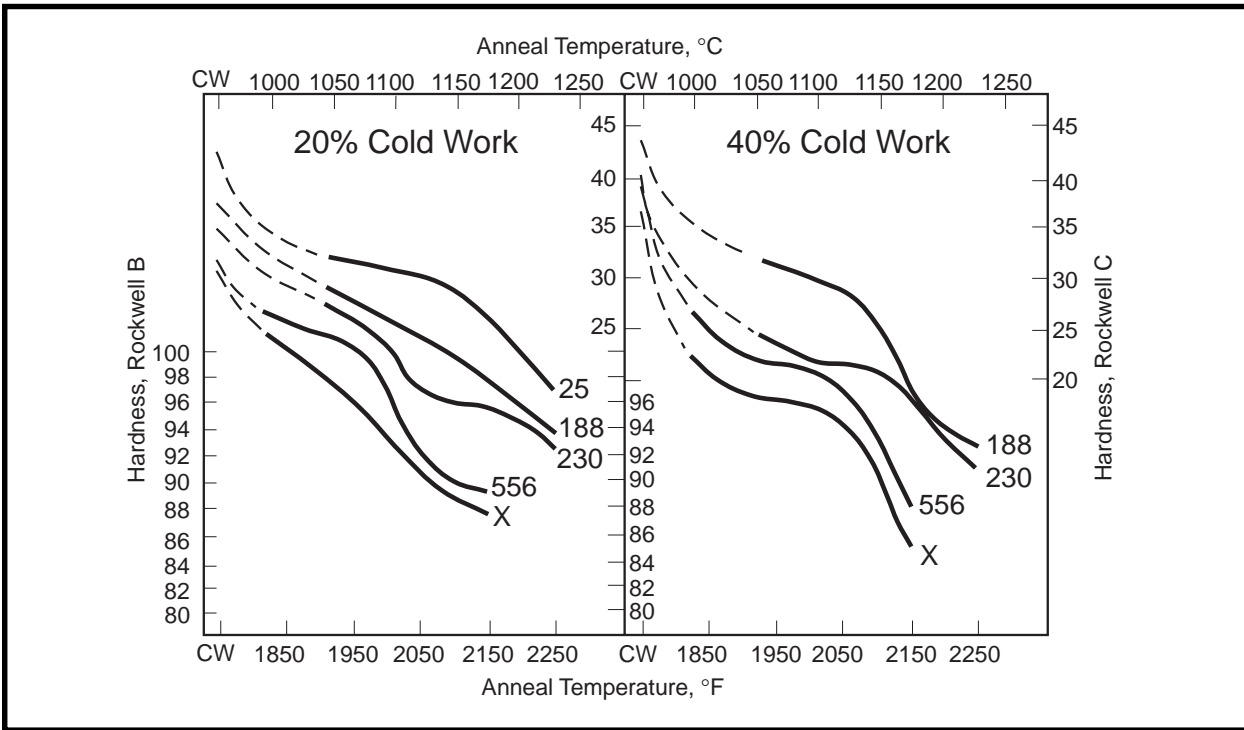
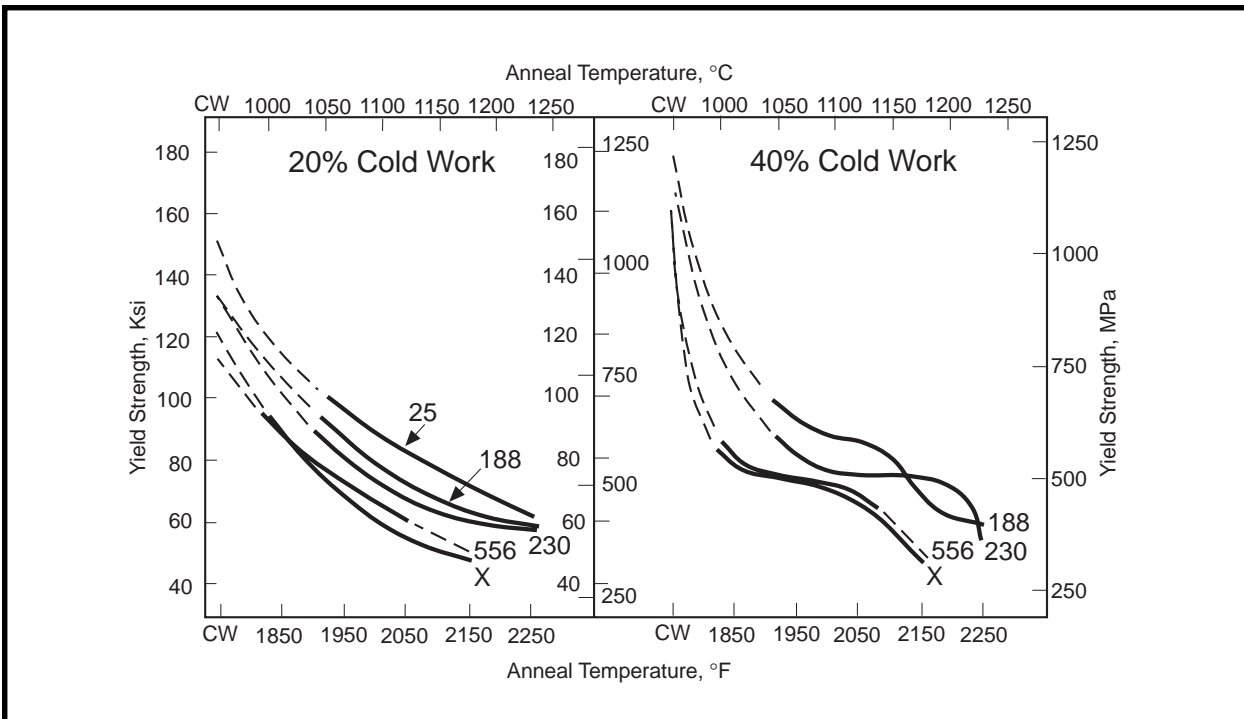
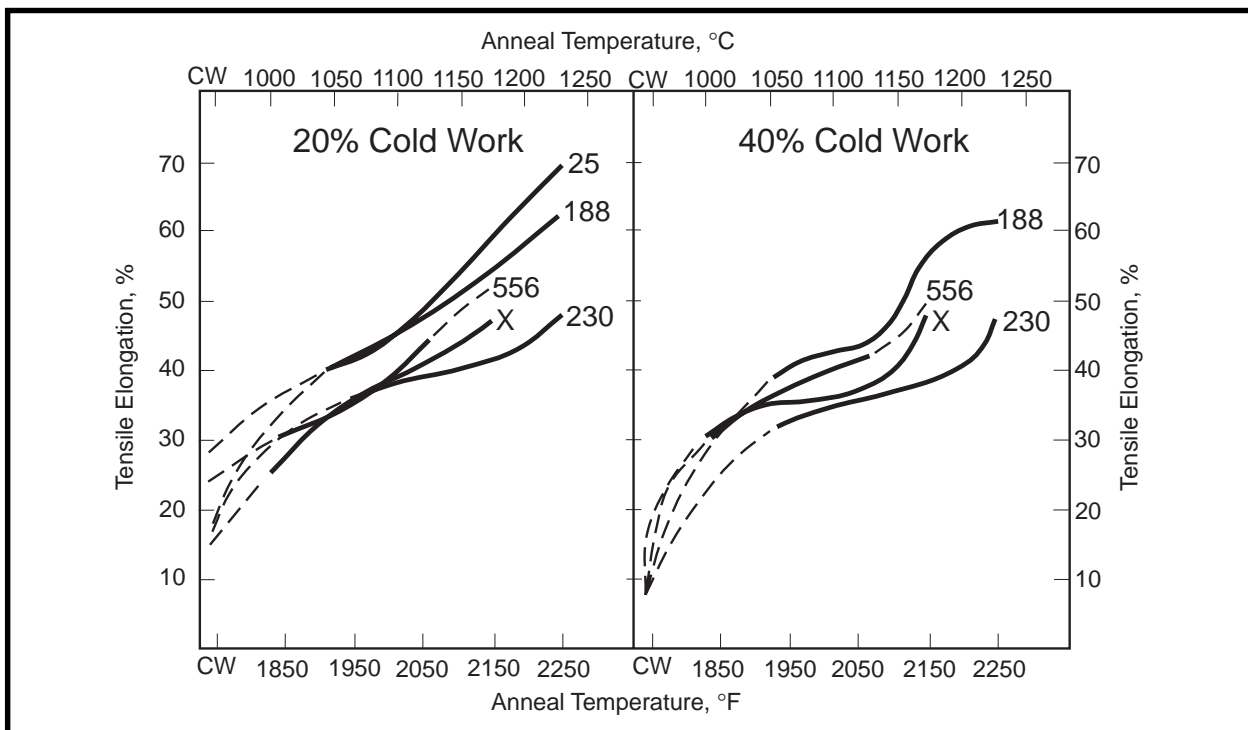

Figure 4  
Effect of Anneal Temperature Upon Yield Strength of Cold-Worked Material



## HEAT TREATMENT (CON'T.)

Figure 5  
Effect of Anneal Temperature Upon Tensile Elongation of Cold-Worked Material



## ANNEALING DURING HOT FORMING

Components manufactured by hot forming techniques should generally be solution heat treated rather than mill annealed (as defined on page 13) if in-process heat treatment is required. In cases where forming is required to be performed at furnace temperatures below the solution treatment range, intermediate mill annealing may be employed subject to the limits of the forming equipment. The amount of hot deformation per session which can be performed under these conditions may be significantly restricted.

Hot-formed components, particularly when formed at high temperatures, will generally undergo recovery, recrystallization, and perhaps even grain growth during the forming operation itself. If forming temperatures are too high relative to the solution annealing temperature used, the structure of the component may not be determined by the anneal, but rather by the forming operation. Similarly, if the hot forming session involves a small amount of deformation, the piece to be heat treated may exhibit a non-uniform structure, which will respond non-uniformly to the heat treatment.

In the case where material is formed at very high temperatures, it may be best to solution treat at the high end of the allowable range, and almost always at a temperature above the forming temperature. For those cases when a small amount of forming deformation is involved, it is advisable to use annealing temperatures at the low end of the allowable solution treatment range to minimize the non-uniformity in the structure of the piece. This last approach is particularly applicable to heavy section thickness pieces, such as large forgings, large size bars, and thick plate materials.



# HEAT TREATMENT (CON'T.)

TABLE 8 - Effect of Small Strain Levels on Annealed Grain Size\*

5-Minute Annealing Temperature °F (°C)	Prior Strain Level %	Predominant Grain Size After Annealing (ASTM)			
		HASTELLOY X alloy	HAYNES 230® alloy	HAYNES 556® alloy	HAYNES 25 alloy
None	0	4 1/2 - 6 1/2	6 1/2 - 7	5 - 6 1/2	3 1/2 - 4
1950 (1065)	1	4 1/2 - 5	6 1/2 - 7	5 - 6 1/2	N/A
	2	4 1/2 - 5	6 1/2 - 7	5 - 6 1/2	N/A
	3	4 1/2 - 5	6 1/2 - 7	5 - 6 1/2	N/A
	4	4 1/2 - 5	6 1/2 - 7	5 - 6 1/2	N/A
	5	4 1/2 - 5	6 1/2 - 7	5 - 6 1/2	N/A
	8	4 1/2 - 5	5 1/2 - 6 1/2	5 - 6 1/2	N/A
2050 (1120)	1	4 - 6 1/2	5 1/2 - 6 1/2	6 - 7	2 - 4 1/2
	2	4 - 6 1/2	5 1/2 - 6 1/2	6 - 7	3 1/2 - 4
	3	4 - 6 1/2	5 1/2 - 6 1/2	6 - 7	3 1/2 - 4
	4	3 1/2 - 6	5 1/2 - 6 1/2	6 - 7	3 1/2 - 4
	5	3 1/2 - 6	5 1/2 - 6 1/2	6 - 7	N/A
	8	3 1/2 - 6	5 1/2 - 6 1/2	6 - 7	4 - 5 1/2
2150 (1175)	1	0 - 5	4 1/2 - 6	4 1/2 - 5	2 - 4 1/2
	2	0 - 5	4 1/2 - 6	4 1/2 - 5	3 1/2 - 4
	3	00 - 1/2	4 1/2 - 6	4 1/2 - 5	3 1/2 - 5 1/2
	4	1 - 5	4 1/2 - 6	2 - 3	3 1/2 - 5 1/2
	5	1 - 3 1/2	1 - 4	4 - 5	N/A
	8	4 1/2 - 5	3 - 4	3 1/2 - 4	4 1/2 - 6
2250 (1230)	1	N/A	0	N/A	1 - 1 1/2
	2	N/A	0	N/A	1 1/2 - 2 1/2
	3	N/A	0	N/A	2 - 4
	4	N/A	1 - 2 1/2	N/A	2 - 4 1/2
	5	N/A	1 - 3 1/2	N/A	N/A
	8	N/A	2 1/2 - 4	N/A	3 - 3 1/2

\*Samples prestrained in a tensile machine to given plastic strain levels

## HEAT TREATMENT (CON'T.)

### FINAL ANNEALING

Solution heat treating (see page 13) is the most common form of finishing operation applied to HAYNES® and HASTELLOY® high-temperature alloys, and is often mandated by the applicable specifications for these materials. Mill annealing (see page 13) is required in some specific cases, such as for Grade I alloy 625 but is less commonly used. Where permitted by relevant specifications, it may be possible to adjust the final structure and properties of the component by selecting a solution treatment temperature at the high or low end of the allowable ranges, as given in Table 6. This is of course dependent upon the amount of cold or warm work present in the piece prior to annealing.

In some cases, where only a minor amount of forming has been done, and the amount of deformation in the piece is less than about 10 percent cold or warm work, it may be advisable to omit a final solution heat

treatment or substitute a stress relief anneal. This is of course subject to specification limitations. Depending upon the individual alloy, and the service conditions under which the component is to be used, leaving the material in the slightly-worked or stress-relieved condition can actually improve some performance characteristics, such as creep strength. This is illustrated for HAYNES 230® alloy by the data in Table 9. As each particular case will be different, it is advisable to contact Haynes International before deciding to take such an approach.

Where more than about 10 percent cold work is present in the piece, a final anneal is usually mandatory. Putting as-cold-worked material into service can result in recrystallization to a very fine grain size, which in turn can produce a significant reduction in stress rupture strength. This is also illustrated for 230 alloy by the data in Table 9.

Unlike mill annealing, which is usually performed as a step unto itself, solution treating may sometimes be combined with another operation which imposes significant constraints upon both heating and cooling practices. A good example of this is vacuum brazing. Often performed as the final step in the fabrication of some components, such a process precludes the possibility of a subsequent solution treatment because of the low melting point of the brazing compound. Consequently, the actual brazing temperatures used are sometimes adjusted to allow for the simultaneous solution heat treating of the component. Since it is the nature of vacuum furnaces that both heating and cooling rates are relatively slow, even with the benefit of advanced gas cooling equipment, it must be recognized that alloy structure and properties produced may be less than optimum.

### STRESS RELIEVING

A stress relief anneal should be considered as such only if the treatment does not produce recrystallization in the material. Relief of residual stress in these alloys, arising from thermal strains produced by non-uniform cooling, or slight deformations imparted during sizing operations, is often difficult to achieve. Stress relief temperatures commonly used for steels and simple Fe-Ni-Cr

or Ni-Cr alloys are generally not effective for HAYNES and HASTELLOY high-temperature alloys.

In many cases, stress relieving at mill annealing temperatures about 100 to 200°F (55 to 110°C) above the intended use temperature will provide good results. In other cases, a full solution anneal at the low end of the allowable range may be

best, although this can make the material subject to abnormal grain growth. At any rate, it should be recognized that any treatment below the bottom of the solution treatment temperature range and above about 1000°F (540°C) may promote grain boundary carbide precipitation in these alloys, with consequent effects upon component properties.

## HEAT TREATMENT (CON'T.)

TABLE 9 - Effect of Cold Work / Anneal Cycles Upon Stress Rupture Properties of HAYNES® 230® Sheet

Cold Work %	5-Minute Annealing Temperature* °F (°C)	Stress Rupture Life (Hours)**		
		1400°F/20 Ksi (760°C/140 MPa)	1600°F/13 Ksi (870°C/90 MPa)	1800°F/5.5 Ksi (980°C/38 MPa)
10	None	-	508	79
	1950 (1065)	-	431	-
	2050 (1120)	1271	156	-
	2150 (1175)	369	50	-
	2250 (1230)	432	73	-
30	None	435	36	9
	1950 (1065)	186	16	-
	2050 (1120)	225	18	-
	2150 (1175)	228	29	-
	2250 (1230)	249	49	-
50	None	147	11	5
	1950 (1065)	138	11	-
	2050 (1120)	204	13	-
	2150 (1175)	214	25	-
	2250 (1230)	269	58	-

\*Air Cooled \*\*Logarithmic average of multiple test results

## HEAT TREATMENT (CON'T.)

### HEATING RATE AND COOLING RATE

Generally speaking, heating rates and cooling rates used in the heat treatments of these alloys should be as rapid as possible. Rapid heating to temperature is usually desirable to help minimize carbide precipitation during the heating cycle, and to preserve the stored energy from cold or warm work required to provide recrystallization and/or grain growth at the annealing temperature. Slow heating can promote a somewhat finer grain size than might otherwise be desired or required, particularly for thin section thickness parts given limited time at the annealing temperature.

Rapid cooling through the temperature range of about 1800°F (980°C) down to 1000°F (540°C) following mill annealing is required to minimize grain boundary carbide precipitation, and other possible phase reactions in some alloys. Where possible, a water quench should be used. The effect of cooling rate is even

more pronounced for solution heat treating. Again, cooling from the solution annealing temperature down to under 1000°F (540°C) should be as rapid as possible considering the constraints of the equipment and the need to minimize component distortion. Water quenching is preferred where feasible.

The sensitivity of individual alloys varies, but most of these alloys will suffer at least some degradation in properties with slow cooling. A typical example of the effect of cooling rate upon the creep properties of HAYNES® 188 alloy is given in Table 10.

**TABLE 10 - Effect of Cooling Rate From Annealing Upon the Creep Life of HAYNES 188 alloy Sheet**

Solution Treat at 2150°F (1175°C) and Cool at Rate Shown	Time to 0.5% Creep for 1600°F/7Ksi (870°C/48 MPa) Test, Hours
Water Quench	148
Air Cool	97
Furnace cool to 1200°F (650°C) and then air cool	48

### HOLDING TIME

Times at temperature required for mill and solution annealing are basically governed by the need to ensure that all metallurgical reactions are complete, uniformly and throughout the component. Time in the furnace will vary with furnace type, geometry, furnace capacity, and material thickness. The actual time at temperature should be determined using

thermocouples attached to the part whenever possible, bearing in mind that sufficient time must be allowed for the entire piece to reach the temperature in question. The old guideline of allowing 1/2 hour per inch of thickness is appropriate more often than not for massive parts.

Once the entire piece is uniformly at temperature, a holding

time of from 5 to 30 minutes is normally sufficient, depending upon section thickness. For continuous strip or wire annealing, several minutes may suffice. Extraordinarily long holding times (such as over night) are not recommended, and can be harmful to alloy structure and properties.

## HEAT TREATMENT (CON'T.)

### USE OF PROTECTIVE ATMOSPHERE

Most of these alloys may be annealed in oxidizing environments, but will form adherent oxide scales which normally must be removed prior to further processing. For details on scale removal, please see the DESCALING AND PICKLING section of this guide. Some HAYNES® and HASTELLOY® high-temperature alloys contain low chromium contents (see page 5, Table 1). Atmosphere annealing of these materials should be performed

in neutral to slightly reducing environments.

Protective atmosphere annealing is commonly performed for all of these materials when a bright finish is desired. The best choice for annealing of this type is a low-dew-point hydrogen environment. Annealing may also be done in argon and helium, although more pronounced tinting from oxygen or water vapor contamination is sometimes encountered.

Annealing in nitrogen or cracked ammonia is not generally preferred, but may be acceptable in some cases.

Vacuum annealing is generally acceptable, but may also produce some tinting depending upon the equipment and temperature. Selection of the gas used for forced gas cooling can also influence results. Helium is normally preferred, followed by argon and nitrogen (in some cases).

### SELECTION OF HEAT TREATING EQUIPMENT

Most industrial furnace types are suitable for heat treating these alloys. Induction heating is generally not preferred, as

control of temperature and temperature uniformity is often inadequate. Heating by torches, welding equipment

and the like is not acceptable. Flame impingement of any type during heat treatment is to be avoided.

# WELDING

The welding characteristics of HAYNES® and HASTELLOY® high-temperature alloys are similar in many ways to those of the austenitic stainless steels and present no special welding problems, if proper techniques and procedures are followed.

As a way of achieving quality production welds, development and qualification of welding procedure specifications is suggested. Such procedures are normally required for code fabrication, and should take into account parameters such as, but not limited to, base and filler materials, welding process, joint design, electrical characteristics, preheat/interpass control, and postweld heat treatment requirements.

Any modern welding power supply with adequate output and controls may be used with the common fusion welding processes. Generally, welding heat input is controlled in the low to moderate range. Wide weave beads are not recommended. Stringer bead welding techniques, with some electrode/torch manipulation, are preferred.

In general, nickel- and cobalt-based alloys will exhibit both sluggish welding and shallow penetration characteristics in comparison to those for steels and austenitic stainless steels. Therefore, care must be used with respect to joint design and weld bead placement to ensure that sound welds with proper weld bead tie-in are achieved. Both nickel- and cobalt-based alloys have a tendency to crater crack, so grinding of starts and stops is recommended.

Cleanliness is considered an important aspect of welding the nickel- and cobalt-based alloys. Contamination by greases, oils, corrosion products, lead, sulfur, and other low melting point elements can lead to severe cracking problems. For iron- and cobalt-based alloys, contact with copper or copper-bearing materials in the weld joint area should be avoided.

Even trace amounts of copper contamination can result in liquid metal embrittlement cracking in the heat-affected-zone of the weld.

Welding processes that are commonly used with these alloys are shown in Table 11. In addition to these common arc welding processes, other welding processes such as plasma arc welding, resistance spot welding, laser beam welding, and electron beam welding can be used. The plasma arc cutting process is commonly used to cut alloy plate into desired shapes and prepare weld angles.

The use of oxyacetylene welding and cutting is not recommended, because of carbon pick-up from the flame. Submerged arc welding can be used, but selection of flux and welding parameters are critical. Contact Haynes International for more information.

TABLE 11

Process	American Welding Society Designation	Common Designation
Gas Tungsten Arc Welding, Manual and Machine	GTAW	TIG
Gas Metal Arc Welding, Manual and Machine	GMAW	MIG
Shielded Metal Arc Welding	SMAW	Stick or Coated Electrode

## WELDING (CON'T.)

### SELECTION OF WELDING FILLER METAL

Selection of the correct welding filler wire for welded joint construction of HAYNES® and HASTELLOY® high-temperature alloys is extremely important. The criteria applied to the selection include not only the ease of welding, but also the soundness and in-service performance characteristics of the weldment as well. This is equally true for selecting welding filler wire for dissimilar metal joining applications.

For matching material welds, selection of a matching composition filler wire is generally

preferred. For heavy section thicknesses (>1/2 in.), a specially formulated version of the base metal composition, or even a completely dissimilar alloy, may be an appropriate filler metal selection to avoid hot cracking in certain alloys, such as HAYNES HR-160® alloy. This is particularly important under conditions of heavy restraint. In some instances, a completely dissimilar alloy is the recommended selection in all cases, such as for HAYNES HR-120® alloy.

Where dissimilar metal welds are involved, selection of the welding filler metal depends upon the specific circumstances. One, both or neither of the two alloys in question may be suitable for the filler metal. Some filler wire alloys supplied by Haynes International are suitable for a broad spectrum of dissimilar welding applications. These include HASTELLOY S and W alloys, as well as HAYNES 25, 556®, and 230-W™ alloys.

TABLE 12 - Haynes International Filler Metal Alloys

Designation	Description	AWS A5.14	AWS A5.11	AMS*
1	HASTELLOY S alloy	-	-	5838
2	HASTELLOY W alloy	ER NiMo-3	E NiMo-3	5786, 5787*
3	HASTELLOY X alloy	ER NiCrMo-2	E NiCrMo-2	5798, 5799*
4	HAYNES 25 alloy	-	-	5796, 5797*
6	HAYNES 188 alloy	-	-	5801
7	HAYNES R-41 alloy	-	-	5800
8	HAYNES HR-160® alloy	-	-	-
9	HAYNES 214® alloy	-	-	-
10	HAYNES 230® alloy	-	-	-
11	230-W™ Filler Wire	ER NiCrWMo-1	-	5839
12	HAYNES 242® alloy	-	-	-
13	HAYNES 263 alloy	-	-	-
14	HAYNES 556® alloy	A5.9 ER 3556	-	5831
15	HAYNES 625 alloy	ER NiCrMo-3	E NiCrMo-3	5837
16	HAYNES 718 alloy	ER NiFeCr-2	-	5832
17	MULTIMET® alloy	-	-	5794, 5795*
18	WASPALOY alloy	-	-	5828

\*Second number is for coated electrodes

## WELDING (CON'T.)

Specific recommendations for filler metal selection are embodied in Tables 12 to 14. Filler metal commercial descriptions, together with appropriate specification designations (where available), are given in Table 12. Recommendations for selection are based upon matching base metal alloy joints ("self"), and dissimilar base metal combinations. The dissimilar combinations are organized by matching the Haynes International base metal alloy to various dissimilar alloy groups. These material groups are given in Table 13. Recommended filler metals for both

matching base metal joints and dissimilar base metal joints are given in Table 14.

It should be recognized that all possible filler metal selections are not given in Table 14, and that not all of the recommendations are based upon actual experience. Where multiple selections are indicated, they are listed in order of preference based upon the likelihood of achieving a high-quality weld joint with the best performance characteristics. Actual filler metal selection may also be influenced by the availability of particular welding consumable

forms for specific alloys. Available forms for Haynes International welding products are listed in Table 15.

Information on filler metal selection for precipitation-strengthened alloys, in addition to that for solid-solution-strengthened materials, has been presented here for the sake of completeness. The former alloys fall outside the scope of this guide, and the other sections of this publication will generally not apply to such materials. Please contact Haynes International for further information.

**TABLE 13 - Dissimilar Base Metal Alloy Groups**

Group	Base Type	Typical Alloys Included
I	Iron-based, ferritics	Carbon, low alloy, high alloy and ferritic stainless steels
II	Iron-nickel-based	Austenitic stainless steels, and RA85H <sup>®</sup> , 253MA <sup>®</sup> , 330, 800, 800H, 800HT <sup>®</sup> , HR-120 <sup>®</sup> , MULTIMET <sup>®</sup> , and 556 <sup>®</sup> alloys
III	Nickel-based, low alloy	825, 600, 601, 75, and 80-20 types
IV	Nickel-based, high Mo/W	HASTELLOY <sup>®</sup> B, N, S, W, and X alloys HAYNES <sup>®</sup> 230 <sup>®</sup> , 242 <sup>®</sup> , 625, and 617 alloys
V	Nickel-based, high Al, Ti or Cb	HAYNES <sup>®</sup> R-41, 214 <sup>®</sup> , 263, 718, and X-750 alloys Waspaloy alloys
VI	Cobalt-based & high cobalt	HAYNES <sup>®</sup> 25, 31, 150, and 188 alloys



# WELDING (CON'T.)

TABLE 14 - Recommended Filler Metals (see alloy designations given in Table 12)

Base Material	Recommended Filler Metals for Various Dissimilar Base Metal Groups					
	Self	I & II (Fe,Fe-Ni)	III (Ni)	IV (Ni/Mo,W)	V (Ni/Al,Ti)	VI (Co)
<b>HASTELLOY® alloys</b>						
B	2,1	14,2	2,1	2,1	2,1	4,2
N	2,1	14,2	2,1	2,1	2,1	4,2
S	1	1,14	1,2	1,2	1,2	4,1
W	2	2,14	2,1	2,1	2,1	4,2
X	3	3,14	3,14,1	3,14,1	2,1,3	4,14,3
<b>HAYNES® alloys</b>						
25	4	14,4	4,6,11	4,6,11	1,11,2	4,6
R-41*	7	1,15,2	1,15,2	1,2	1,2	1,11,2
75	1,11	14,11	1,11	1,2	1,2	14,4,11
HR-120®	14,17,3	14,17,3	14,1,3	1,14,3	1,2	14,4,11
150	14,17	14,4	14,4	14,4	1,2	14,4
HR-160®	Contact Haynes International for Information					
188	6	14,4	6,14,4	6,14,4	1,11,2	6,4
214* <sup>⊗</sup>	9,1	1,15,2	1,15,2	1,2	1,2	1,11,2
230®	11	14,11	11,14,3	11,1,2	11,1,2	11,14,4
242* <sup>⊗</sup>	12	12,14	12,1,2	12,1,2	12,1,2	12,11,4
263*	13	1,15,2	1,15,2	1,2	13,1,2	1,11,2
556* <sup>⊗</sup>	14	14,17	14,3	14,1,3	1,2	14,4
625	15	15,14	15,1,2	15,1,2	1,2	14,4,15
718*	16	1,15,2	1,15,2	1,2	16,1,2	14,4,11
X-750*	16	1,15,2	1,15,2	1,2	16,1,2	14,4,11
Waspaloy*	18	1,15,2	1,15,2	1,2	1,2	1,11,2
MULTIMET® alloy	17,14	14,17	14,17,3	17,1,3	1,2	14,4,17

\* The fabrication characteristics of these alloys are outside the scope of this Fabrication Guide. Please contact Haynes International for further information.

## WELDING (CON'T.)

TABLE 15 - Available Forms for Haynes International Filler Metals

Filler Material	Straight Lengths <sup>1</sup>	Layer Wound Spools <sup>2,3</sup>	Coated Electrodes <sup>4</sup>	Loose Coils <sup>5</sup>
HASTELLOY® W and X alloys; HAYNES® 25 alloy; 230-W filler wire; MULTIMET® alloy	Yes	Yes	Yes	Yes
HASTELLOY S alloy; HAYNES R-41, 188, 263, 625 and 718 alloys; Waspaloy alloy; 214, 230-W, 242, 556, and HR-160 alloys.	Yes	Yes	No	Yes

<sup>1</sup> 36-inch (0.9 m) length standard; 0.035, 0.045, 0.062, 0.094, and 0.125-inch (0.9, 1.1, 1.6, 2.4, and 3.2 mm) diameter standard. Other sizes available upon request.

<sup>2</sup> 25 pound (11.4 kg) standard coil; 0.035, 0.045 and 0.062-inch (0.9, 1.1 and 1.6 mm) diameter standard. Other sizes available upon request.

<sup>3</sup> 10 pound (4.5 kg) spools available in selected alloys, such as 230-W filler wire and 214 alloy.

<sup>4</sup> 14-inch (0.36 m) standard length for 0.125 and 0.156-inch (3.2 and 4.0 mm) diameters. 9-inch (0.23 m) length standard for 0.094-inch (2.4 mm) diameter.

<sup>5</sup> 50 pound (22.7 kg) minimum coils; 0.035 to 0.187-inch (0.9 to 4.8 mm) diameters.

## WELD JOINT DESIGN

Selection of a correct weld joint design is critical to the successful fabrication of HAYNES and HASTELLOY high-temperature alloys. Poor joint design can negate even the most optimum selection of welding filler metal.

Various welding documents are available to assist in the design of welded joints. Two such documents that provide guidance are American Welding Society, [Welding Handbook](#), Volume 1, Eighth Edition, Chapter 5 and ASM International, [Metals Handbook](#), Volume 6, Welding, Brazing and Soldering, Joint Design and

Preparation. In addition, fabrication codes such as the ASME Pressure Vessel and Piping Code may impose design requirements.

Typical butt joint designs that are used with the gas tungsten arc welding (GTAW), gas metal arc welding (GMAW), and shielded metal arc welding (SMAW) processes are (I) Square-Groove, (II) Single-V-Groove, and (III) Double-V-Groove shown in Figure 6. Gas tungsten arc welding is often the preferred method for depositing the root pass associated with the square-groove (Joint I) or

single-groove (Joint II) where access to only one side of the joint is possible. The remainder of the joint can then be filled using other welding processes as appropriate. For groove welds on heavy section plates greater than 3/4 inch (19 mm) thick, a J-groove is permissible. Such a joint reduces the amount of filler metal and time required to complete the weld. Other typical welding joint designs are shown in Figure 7. The actual number of passes required to fill the joint depends upon a number of factors that include the filler

## WELDING (CON'T.)

### WELD JOINT DESIGN (CON'T.)

metal size (electrode or wire diameter), the amperage, and the travel speed.

It should be recognized that nickel- and cobalt-based alloy weld metal is sluggish (not as fluid as carbon steel) and does not flow out as readily and "wet" the sidewalls. Therefore, the welding arc and filler metal must be manipulated so as to

place the molten metal where needed. In addition to the sluggishness, the joint penetration is also less than that of a typical carbon or stainless steel weld. With this low penetration pattern, the possibility of incomplete fusion increases. As a result of these factors, care must be taken to insure that the groove opening is wide enough to allow proper torch or

electrode manipulation and placement of the weld bead.

A general estimate of filler metal requirements is about four to five percent (by weight) of the base plate requirement. Estimated weight of weld metal required per unit length of welding is given in Table 16.

Figure 6  
Typical Butt Joints for Manual Welding

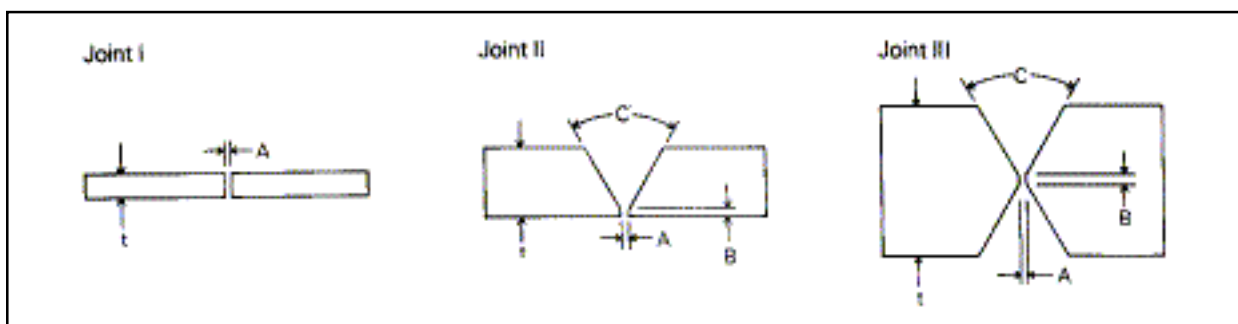
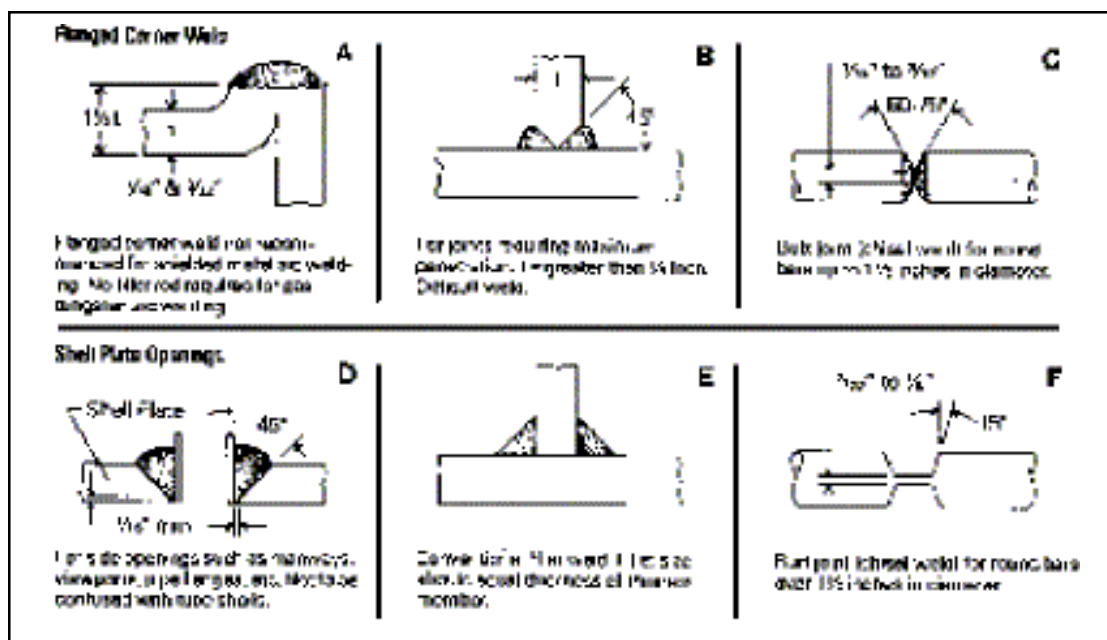

TABLE 16

Material Thickness (t), in. (mm)	Preferred Joint Design	Root Opening (A), in (mm)	Land Thickness (B) in (mm)	Included Weld Angle (C), degrees	Approx. Weight of Weld Metal Required, lbs/ft (kg/m)
1/16 (1.6)	I	0-1/16 (0-1.6)	N/A	None	0.02 (0.03)
3/32 (2.4)	I	0-3/32 (0-2.4)	N/A	None	0.04 (0.06)
1/8 (3.2)	I	0-1/8 (0-3.2)	N/A	None	0.06 (0.09)
1/4 (6.3)	II	1/16-1/8 (1.6-3.2)		60-75	0.30 (0.45)
3/8 (9.5)	II			60-75	0.60 (0.89)
1/2 (12.7)	II			60-75	0.95 (1.41)
1/2 (12.7)	III	1/32-5/32	1/32-3/32	60-75	0.60 (0.89)
5/8 (15.9)	II	(0.8-4.0)	(0.8-2.4)	60-75	1.40 (2.08)
5/8 (15.9)	III			60-75	0.82 (1.22)
3/4 (19.1)	II			60-75	1.90 (2.83)
3/4 (19.1)	III			60-75	1.20 (1.79)

## WELDING (CON'T.)

Figure 7  
Other Joint Designs for Specific Situations\*



\* Flanged corner welds (A) and fillet welds (E) are not recommended for these alloys, and should be avoided whenever possible. These and other partial penetration welds are particularly sensitive to cracking in service.

## CLEANING, EDGE PREPARATION AND FIT-UP

Proper preparation of the weld joint region is a very important part of the welding of nickel- and cobalt-based alloys. A variety of mechanical and thermal cutting methods are available for the preparation of weld angles. Plasma cutting/gouging, machining, grinding, and air arc gouging are all potential processes. It is necessary to condition all thermal cut edges to bright, shiny metal prior to welding. (This is particularly important if air arc gouging is being used due to the extreme possibility of carbon pick-up from the carbon electrode.)

In addition to the weld angle, a 1 inch (25 mm) wide band on the top and bottom (face and root) surface of the weld zone should be conditioned to bright metal with about an 80 grit flapper wheel or disk.

The welding surface and adjacent regions should be thoroughly cleaned with an appropriate solvent prior to any welding operation. All greases, oils, cutting oils, crayon marks, machining solutions, corrosion products, paint, scale, dye penetrant solutions, and other foreign matter should be completely removed.

Stainless steel wire brushing is normally sufficient for interpass cleaning of GTAW and GMAW weldments. The grinding of starts and stops is recommended for all fusion welding processes. If oxygen or carbon dioxide bearing shielding gases are used during gas metal arc welding, light grinding is necessary between passes prior to wire brushing. Slag removal during shielded metal arc welding will require chipping and grinding followed by wire brushing.

## WELDING (CON'T.)

### PREHEAT, INTERPASS TEMPERATURES, AND COOLING TECHNIQUES

Preheating of HAYNES® and HASTELLOY® corrosion and heat-resistant alloys is not required. Preheat is generally specified as room temperature (typical shop conditions). Interpass temperature should be maintained below 200°F (93°C).

The alloy base plate may require warming to raise the temperature above freezing or to prevent condensation of moisture. Condensation may occur if the alloy is brought into a warm shop from cold outdoor storage. Warming should be accomplished by indirect

heating if possible (infrared heaters or natural heating to room temperature).

If oxyacetylene warming is used, the heat should be applied evenly over the base metal rather than in the weld zone. The torch should be adjusted so that the flame is not carburizing. A "rosebud" tip, which distributes the flame evenly, is recommended. Care should be taken to avoid local or incipient melting as a result of the warming process.

Auxiliary cooling methods may be used to control the interpass

temperature. Water quenching is acceptable. Care must be taken so that the weld zone is not contaminated with traces of oil from shop air lines, grease/dirt from soiled water-soaked rags or mineral deposits from hard water used to cool the weld joint. The safest way to maintain a low interpass temperature is to allow the assembly to cool naturally. When attaching hardware to the outside of a thin-walled vessel, it is good practice to provide auxiliary cooling to the inside (process side) to minimize the extent of the heat-affected-zone.

### POSTWELD HEAT TREATMENT

Postweld heat treatment of HAYNES and HASTELLOY solid-solution-strengthened high-temperature alloys is not generally required to assure

proper weldment performance. Heat treatment of welded fabrications may be required for other reasons, such as stress relief. In these cases, the

selection of an appropriate heat treatment will be governed by the various criteria discussed in the HEAT TREATMENT section of this guide.

### INSPECTION AND REPAIR

Good manufacturing practice suggests that some degree of nondestructive testing (NDT) be conducted. For code fabrications, certain mandatory NDT inspections may be required. For non-code fabrication, NDT may be as simple as visual inspection or dye penetrant inspection. NDT should be considered for both intermediate quality control inspections during fabrication, as well as for final acceptance tests.

Welding defects that are believed to affect quality or mechanical integrity should be removed and weld-repaired. Removal techniques include grinding, plasma arc gouging, and carbon arc gouging. Extreme care must be used during carbon arc gouging to insure that carbon contamination of the weld zone does not occur.

Generally the prepared cavity is dye penetrant inspected to insure that all objectionable

defects have been removed, and then thoroughly cleaned prior to welding repair. Because these alloys have low penetration characteristics, the ground cavity must be broad enough and have sufficient sidewall clearance in the weld groove to allow weld rod/weld bead manipulation. "Healing cracks" or "washing out" defects by autogenously remelting weld beads or by depositing additional filler metal over the defect is not recommended.

## WELDING (CON'T.)

### CONTROL OF DISTORTION

Distortion characteristics of HAYNES® and HASTELLOY® high-temperature alloys are similar to those of the austenitic stainless steels. Figure 8 is included to show possible changes in weld joint shape.

Jigs, fixturing, cross supports, bracing, and bead placement/weld sequence will help to hold distortion to a minimum. Where possible, balanced welding about the neutral axis will assist in keeping distortion to a minimum. Proper fixturing and clamping of the assembly

makes the welding operation easier and minimizes buckling and warping of thin sections.

It is suggested that, where possible, extra stock be added to the overall width and length. Excess material can then be removed to obtain final dimensions.

Figure 8  
Control of Distortion

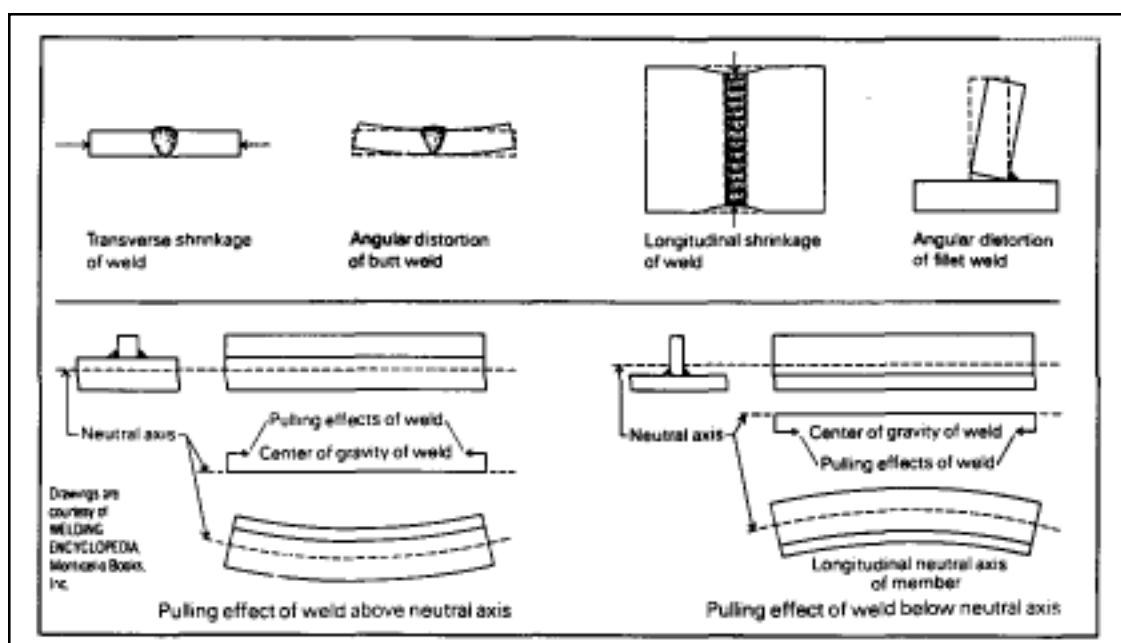

### CRACKING PROBLEMS

Hot cracking is a condition generally confined to the fusion zone but occasionally can occur in the heat-affected-zone. Two conditions are necessary to produce hot cracking: stress and a "strain intolerant microstructure". The creation of stress is inevitable during welding because of the complex thermal stresses that are created when metal solidifies. "Strain intolerant microstructures" temporarily occur at elevated temperatures near the melting and solidification point

of all alloys. Surface contaminants such as sulfur can contribute to hot cracking. Certain geometric features such as concave weld deposits and tear-drop shaped weld pools can also lead to hot cracking. For each alloy system, a critical combination of these conditions can produce hot cracking.

Cold cracking will occur in solidified weld metal and in base material only when externally applied stresses exceed the tensile strength of the alloy.

Classical hydrogen embrittlement is not a fabrication cracking problem in nickel- and cobalt-based alloys.

Bead shape can play a role in weld metal cracking. Root pass weld beads that have a concave shape can crack during root pass welding. This results from the applied stresses exceeding the strength limit of the very small weld bead cross-section. Convex weld beads and clamps/fixtures can control this cracking problem.

## WELDING (CON'T.)

### SPECIFIC CONSIDERATIONS: GAS TUNGSTEN ARC WELDING

The gas tungsten arc welding (GTAW) process is a very versatile, all-position welding process. It can be used in production as well as repair situations. It can be used manually or adapted to automatic equipment to weld thin sheet or plate material. It is a process that offers great control and is therefore routinely used during tack welding and root pass welding. The major drawback of the process is productivity. For manual welding situations, GTAW weld metal deposition rates are low.

Generally, power supplies equipped with high-frequency start, pre-purge/post-purge and up-slope/down-slope (or foot peddle) controls are recommended. It is recommended that the GTAW welding torch be equipped with a gas diffuser screen ("gas lens") to provide optimum shielding gas coverage. Generally, the gas cup should be as large as practical.

Typical welding parameters, which are suggested for the HAYNES® and HASTELLOY® high-temperature alloys, are

presented in Table 17. Electrical polarity should be direct current electrode negative (DCEN).

Two percent thoriated tungsten electrodes are recommended. The classification for these electrodes is EWTh-2 (American Welding Society Specification A5.12). The diameter of the tungsten electrode will vary with amperage. General recommendations for electrode diameter selection are given in Table 17. It is recommended that the electrode be ground to a cone shape (included angle of 30 to 60 degrees) with a small 1/16 inch (1.6 mm) flat ground at the point. See Figure 9 for details.

Welding grade argon (99.996 percent minimum purity) shielding gas is recommended for all normal fabrication situations. The flow rates are normally in the 25-30 cubic feet per hour range. When proper shielding is achieved, the as-deposited weld metal should have a bright-shiny appearance and require only minor wire brushing between passes. On special occasions, argon-helium or argon-hydrogen shielding gases

are used in high travel speed, highly mechanized welding systems.

In addition to welding torch shielding gas, a back-purge at the root side of the weld joint is recommended (welding grade argon). The flow rates are normally in the 5 to 10 cubic feet per hour range. Often backing bars (usually copper) are used to assist in bead shape on the root side of GTAW welds. Backing gas is often introduced through small holes along the length of the backing bar.

There are situations where backing bars cannot be used. Under these conditions, open-butt welding is often performed. Such welding conditions are often encountered during pipe or tube circumferential butt welding. Under these conditions where access to the root side of the joint is not possible, special gas flow conditions have been established which differ from the industry recommendations published elsewhere. Under these open-butt welding conditions, the torch flow rates

TABLE 17 - Typical Manual Gas Tungsten Arc Parameters (Flat Position)\*

Joint Thickness in (mm)	Tungsten Electrode Diameter in (mm)	Filler Wire Diameter in (mm)	Welding Current Amps	Volts
0.030-0.063 (0.8-1.6)	0.063 (1.6)	0.063 (1.6)	15-60	9-12
0.063-0.125 (1.6-3.2)	0.063/0.094 (1.6/2.4)	0.063/0.094 (1.6/2.4)	50-95	9-12
0.125-0.250 (3.2-6.3)	0.094/0.125 (2.4/3.2)	0.094/0.125 (2.4/3.2)	75-150	10-13
0.250 (6.3) and up	0.094/0.125 (2.4/3.2)	0.094/0.125 (2.4/3.2)	95-200	10-13

\* DCEN



## WELDING (CON'T.)

are reduced to about 10 cubic feet per hour and the back purge flow rates are increased to about 40 cubic feet per hour.

A detailed brochure is available concerning back-purging during pipe welding (ask for Brochure H-2065).

It is recommended that the torch be held essentially perpendicular to the work piece. Stringer bead techniques, using only enough current to melt the base material and allow proper fusion of the filler, are recommended.

During welding, the tip of the welding filler material should

Figure 9  
Tungsten Electrode Geometry

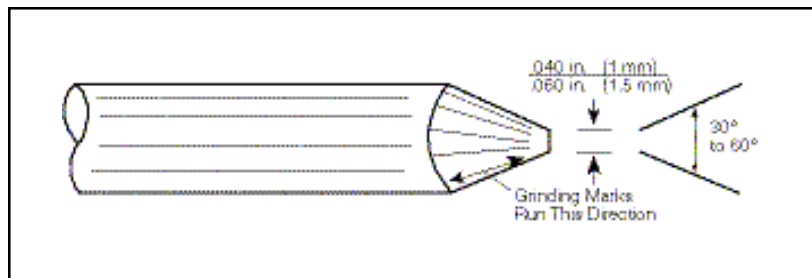

always be held under the shielding gas to prevent oxidation of the hot welding filler wire. Standing still or puddling the weld adds to the welding heat input and is not recommended. Since the welder

controls filler metal additions to the weld puddle, care must be taken to ensure that the resultant weld bead dilution of the base materials is minimized.

## SPECIFIC CONSIDERATIONS: GAS METAL ARC WELDING

The gas metal arc welding (GMAW) process provides considerable increase in productivity when compared to the gas tungsten arc welding process. It is well suited for both manual and automatic welding situations. The weld metal deposition rate is considerably higher, but to some extent, control and ease of operation are reduced with the GMAW process.

Three modes of weld metal transfer are possible with gas metal arc welding. They are short circuiting transfer, globular transfer, and spray transfer. The short arc transfer mode is used in all welding positions, provides good weld puddle

control, and is considered to be a low heat input welding process. However, because the process operates at low amperage, it is often regarded as a defect (cold lap) prone process. The globular mode of weld metal transfer is rarely recommended by Haynes International, except for weld overlay applications. The spray transfer mode is useful only in the flat position and is characterized as a moderate to high heat input welding process with relatively high deposition rates. The pulse-spray mode (a modified spray transfer mode) is useful in all welding positions and is less susceptible to cold lap defects when compared to short circuiting mode.

Constant current, fixed frequency pulse, variable slope/ inductance, and synergic welding power supplies can all be used with the GMAW welding process. The selection of weld metal transfer mode (spray, synergic, pulse-spray, or short circuiting mode) must be decided upon first. Such a decision requires information on joint design/ thickness, welding position to be used, required deposition rates, and welder skill levels. From that information, the welding power supply and welding parameter selections can be made.



## WELDING (CON'T.)

### GAS METAL ARC WELDING (CON'T.)

Typical welding parameters, for the various weld metal transfer modes, are documented in Table 18. Electrical polarity is direct current electrode positive (DCEP).

Shielding gas selection is critical during GMAW procedure development. Five welding grade shielding gases are suggested for the HAYNES® and HASTELLOY® alloys. Those gases are 75 percent argon + 25 percent helium (Ar+He), 90 percent helium + 7.5 percent argon + 2.5 percent carbon dioxide (He+Ar+CO<sub>2</sub>), 66.1 percent argon + 33 percent helium + 0.9 percent carbon dioxide (Ar+He+CO<sub>2</sub>), a proprietary argon-helium-carbon dioxide mixture known as NiCoBRITE™ gas, and 100 percent argon (Ar).

Generally, shielding gas flow rates are in the 35 cubic feet per hour range. The welding torch gas cup size is suggested to be as large as possible. It is suggested that the welding torch be held nearly perpendicular to the work piece. If the torch angle is held too far from perpendicular, oxygen from the atmosphere may be drawn into the weld zone and contaminate the molten metal.

As noted in Table 18, either, Ar+He+CO<sub>2</sub>, He+Ar+CO<sub>2</sub>, or NiCoBRITE shielding gases produces a very stable arc,

excellent out-of-position characteristics and excellent alloy-to-carbon steel welding characteristics. However, because carbon dioxide is present, the weld metal surface will be highly oxidized. This oxidized condition can increase the possibility of lack-of-fusion defects. It is therefore strongly recommended that multipass welds, made with CO<sub>2</sub> containing gases, be lightly ground between passes to remove the oxidized surface.

The use of Ar+He in the short circuit mode is characterized by some spatter and some degree of arc instability when compared to welds made with CO<sub>2</sub> bearing gases. Because this shielding gas is inert, the surface is expected to be bright and shiny with minimal oxidation. During multipass welding, it is not mandatory to grind between passes. This situation also applies to the other modes of weld metal transfer when using Ar+He shielding gas.

In spray transfer welding, even though 100 percent argon shielding gas is used, some oxidation and "soot" may be noted on the weld surface. Heavy wire brushing and/or light grinding/conditioning (80 grit) between passes is recommended.

During spray transfer welding, a water-cooled welding torch is always recommended. During

synergic welding, a water-cooled torch is recommended when current exceeds approximately 120 amps.

As with gas tungsten arc welding, back-purging is required to insure the root side of the weld joint is not heavily oxidized. As an alternative, many fabricators weld without back-purge shielding. They then grind the root side after welding to remove all oxidized weld metal and defects, dye penetrant check the weld zone and then fill the weld joint from both sides as needed.

It should be recognized that the filler wire conduit liner assembly and contact tips (part of the GMAW welding torch) are high wear items and should be expected to be replaced periodically. Wear of the liner occurs as a result of galling between the carbon steel liner and the alloy filler wire. A worn liner will cause erratic wire feed which will result in arc instability. Some welding torches can be fitted with a nylon conduit liner. Such a liner would be expected to reduce wear and thus increase conduit life.

It is recommended that sharp bends in the GMAW torch cable be minimized. If possible, move the wire feeder so that the torch cable is nearly straight during welding.

## WELDING (CON'T.)

TABLE 18 - Typical Gas Metal Arc Welding Parameters (Flat Position)\*

Wire Diameter in. (mm)	Shielding Gas**	Welding Current, Amps	Welding Voltage, Volts	Wire Feed Speed, in./min. (m/min.)	Joint Thickness in. (mm)
Short Circuiting Mode					
0.035 (0.9)	Ar+He	70-90	18-20	150-200 (3.8-5.1)	0.050-3/16 (1.3-4.8)
	He+Ar+CO <sub>2</sub>	70-90	17-20		
	Ar+He+CO <sub>2</sub>	70-90	17-20		
0.045 (1.1)	Ar+He	100-160	19-22	175-225 (4.4-5.7)	1/8-3/4 (3.2-19.1)
	He+Ar+CO <sub>2</sub>	100-160	19-22		
	Ar+He+CO <sub>2</sub>	100-160	19-22		
Spray Transfer Mode					
0.045 (1.1)	Ar	190-250	30-32	300-350 (7.6-8.9)	3/8 (9.5)
	Ar+He+CO <sub>2</sub>	190-225	30-32	275-325 (7.0-8.3)	and up
Fixed Frequency Pulse Mode (60 & 120 CPS)					
0.045 (1.1)	Ar+He	120-150	18-20	175-225	1/8-3/4
		peak, 250-300		(4.4-5.7)	(3.2-19.1)
	Ar+He+CO <sub>2</sub>	120-150	18-20	175-225	1/8-3/4
		peak, 250-300		(4.4-5.7)	(3.2-19.1)
Synergic Mode***					
0.035 (0.9)	Ar+He	50-125	-	-	0.062 (1.6) and up
	Ar+He+CO <sub>2</sub>	50-125	-	-	0.062 (1.6) and up
0.045 (1.1)	Ar+He	100-175	-	-	3/16 (4.8) and up
	Ar+He+CO <sub>2</sub>	100-175	-	-	3/16 (4.8) and up

\* DCEP

\*\* Ar+He=75% argon+25% helium; He+Ar+Co<sup>2</sup>=90% helium+7.5% argon+2.5% carbon dioxide; Ar+He+Co<sup>2</sup>=69% argon+30% helium+1% carbon dioxide; Ar=100% argon.

\*\*\* Detailed welding parameters are difficult to report because each welding machine uses unique set-up parameters to achieve proper welding characteristics.

## SPECIFIC CONSIDERATIONS: SHIELDED METAL ARC WELDING

The shielded metal arc welding (SMAW) process is well known for its versatility because it can be used in all welding positions, and in both production and repair situations. It is generally not useful on thin-sheet material. It requires no special equipment and can be operated easily in remote locations. It is strictly a manual welding process.

Welding electrodes available from Haynes International use lime-titania based coating formulations and are generally classified as slightly basic to slightly acidic depending on the particular alloy. All electrodes are classified as AC-DC, but are recommended to be used with direct current electrode positive (DCEP) electrical characteristics.

All welding electrodes should be stored in a dry rod oven after the container has been opened. It is recommended that the dry rod oven be maintained at about 250 to 400°F (120 to 205°C). If electrodes are exposed to an uncontrolled atmosphere, they can be reconditioned by heating in an oven at 600 to

## WELDING (CON'T.)

### SHIELDED METAL ARC WELDING (CON'T.)

700°F (315 to 370°C) for 2 to 3 hours. Typical welding parameters are presented in Table 19 for flat position welding. For maximum arc stability and control of the molten puddle, it is important to maintain a short arc length. The electrode is generally directed back toward the molten puddle (backhand welding) with about a 20 to 40 degree drag angle. As a general statement, stringer bead welding techniques are recommended. Some electrode manipulation is required to place the molten weld metal

where needed. The maximum manipulation width is about three times the electrode core wire diameter.

Out-of-position welding is recommended only with the 3/32 inch and 1/8 inch (2.4 mm and 3.2 mm) diameter electrodes. During out-of-position welding, the amperage is reduced to the low end of the range. In order to keep the bead profile relatively flat during vertical welding, a weave bead technique is necessary.

Using 3/32 inch (2.4 mm) electrodes will reduce the weave width and produce flatter beads. In vertical welding, a range of electrode positions is possible from forehand (up to 20 degree push angle) to backhand drag welding (up to 20 degree drag angle), depending on welder preference. In over head welding, backhand welding (drag angle 0 to 20 degrees) is required.

TABLE 19 - Typical Shielded Metal Arc Welding Parameters (Flat Position)

Electrode Diameter in. (mm)	Approximate Welding Voltage Volts	Welding Current (DCEP)	
		Aim Amps	Range Amps
3/32 (2.4)	22-24	65-70	55-75
1/8 (3.2)	22-24	90-100	80-100
5/32 (4.0)	22-25	130-140	125-150
3/16 (4.8)	24-26	160-170	150-180

## HEALTH AND SAFETY INFORMATION

Those involved with the welding industry are obligated to provide safe working conditions and be aware of the potential hazards associated with welding fumes, gases, radiation, electrical shock, heat, eye injuries, burns, etc. Various local, municipal, state, and federal regulations (OSHA, for example) relative to the welding and cutting processes must be considered.

Nickel-, cobalt-, and iron-based alloy products may contain, in varying concentrations, the following elemental constituents: aluminum, cobalt, chromium, copper, iron, manganese, molybdenum, nickel, and tungsten. For specific concentrations of these and other elements present, refer to the Material Safety Data Sheets (MSDS) H2071 and H1072 for the product.

The operation and maintenance of welding and cutting equipment should conform to the provisions of American National Standard ANSI Z49.1, Safety in Welding and Cutting. Attention is especially called to Section 4 (Protection of Personnel), Section 5 (Ventilation), and Section 7 (Confined Spaces) of that document. Adequate ventilation is required during all welding and cutting operations. Specific requirements are included in Section 5 for natural ventilation versus mechanical ventilation methods. When welding in confined spaces, ventilation shall also be sufficient to assure adequate oxygen for life support.

The following precautionary warning, which is supplied with all welding products, should be provided to, and fully understood by, all employees involved with welding.

### Caution

*Welding may produce fumes and gases hazardous to health. Avoid breathing these fumes and gases.*

*Use adequate ventilation. See ANSI/AWS Z49.1, Safety in Welding and Cutting published by the American Welding Society.*

*EXPOSURES: Maintain all exposures below the limits shown in the Material Safety Data Sheet, and the product label. Use industrial hygiene air monitoring to ensure compliance with the recommended exposure limits. ALWAYS USE EXHAUST VENTILATION .*

*RESPIRATORY PROTECTION: Be sure to use a fume respirator or air supplied respirator when welding in confined spaces or where local exhaust or ventilation does not keep exposure below the PEL and TLV limits.*

*WARNING: Protect yourself and others. Be sure the label is read and understood by the welder. FUMES and GASES can be dangerous to your health. Overexposure to fumes and gases can result in LUNG DAMAGE. ARC RAYS can injure eyes and burn skin. ELECTRIC SHOCK can kill.*

## BRAZING

Brazing is a process for joining metals where a filler metal alloy, with a lower melting point than the base metal(s) being joined, is melted and resolidified between adjacent base metal surfaces, forming a metallurgical bond. HAYNES® and HASTELLOY® solid-solution-strengthened high temperature alloys may be successfully brazed using a variety of nickel-based, cobalt-based, or gold-nickel brazing

filler metal alloys. Furnace brazing is the most common form of non-welding technique used, and discussion is limited to that process.

The keys to successful brazing of HAYNES and HASTELLOY high-temperature alloys are:

- Thorough cleaning of base metal surfaces,

- Proper filler metal selection for the application,
- Proper fit-up and fixturing during brazing,
- Proper protective environment during brazing,
- Minimizing base metal metallurgical reactions during the brazing thermal cycle.

## BASE METAL SURFACE PREPARATION

All forms of surface contamination, including dirt, paint, grease, ink, chemical residue, oxides, and scale must be removed from the mating parts prior to brazing to ensure wetting of the base metal by the brazing filler metal. Once cleaned, the parts should be assembled as soon as possible, and should be handled using

clean gloves to prevent recontamination.

Although generally not required for base metal alloys containing low aluminum and titanium contents, some HAYNES and HASTELLOY high-temperature alloys may benefit from the application of a thin nickel flashing layer before brazing.

This is normally applied by electroplating. Electroless nickel deposits using nickel-phosphorus alloys are not recommended. Thicknesses of the nickel flashing layer of up to about 0.001 inch (25 μm) maximum are normally employed, depending upon the base metal alloy(s) and the specific joint geometry.

## BRAZING FILLER METAL SELECTIONS

The nickel- and cobalt-based brazing filler metal alloys used for joining the HAYNES and HASTELLOY high-temperature alloys are generally high in boron and/or silicon content. The exact contents of these elements are adjusted to provide specific melting points

to accommodate brazing at different temperatures. The alloys may also contain chromium to provide for more oxidation-resistant joints. Typical standard brazing filler metal alloys used, including gold-based materials, are listed in Table 20.

Selection among these and other brazing filler metal alloys is often dictated by component design, base metal alloy, and service conditions. Please contact braze metal manufacturers for further information.

## BRAZING (CON'T.)

TABLE 20 - Standard Brazing Filler Metal Alloys For HAYNES and HASTELLOY High-Temperature Alloys

Designation/Specification		Descriptive Composition (%)	Brazing Temperature Range	
AWS	AMS		°F	°C
BNi-1	4775	Ni-14Cr-3.1B-4.5Si-4.5Fe-0.75C	1950-2200	1065-1205
BNi-1a	4776	Ni-14Cr-3.1B-4.5Si-4.5Fe-0.06C	1970-2200	1075-1205
BNi-2	4777	Ni-7Cr-3.1B-4.5Si-3Fe-0.06C	1850-2150	1010-1175
BNi-3	4778	Ni-3.1B-4.5Si-0.5Fe-0.06C	1850-2150	1010-1175
BNi-4	4779	Ni-1.9B-3.5Si-1.5Fe-0.06C	1850-2150	1010-1175
BNi-5	4782	Ni-19Cr-0.03B-10.1Si-0.10C	2100-2200	1150-1205
BAu-4	4787	Au-18Ni	1740-1840	950-1005
BAu-5	4785	Au-36Ni-34Pd	2130-2250	1165-1230
BCo-1	4783	Co-19Cr-17Ni-8Si-4W-1Fe -0.8B-0.40C	2100-2250	1150-1230

## FIT-UP AND FIXTURING

Proper fit-up of parts prior to brazing is essential for achieving good results. Appropriate joint gap clearances must be maintained at the brazing temperature to facilitate uniform flow of the molten braze metal throughout the joint area. Reduction of any excessive stresses acting upon the joint during brazing will minimize the possibility of cracking problems. Basic steps which can aid in this regard are (1) making sure that the base metal parts are not initially in a highly

stressed condition (i.e., cold-worked) and (2) making use of appropriate joint fixturing during furnace brazing.

Fixtures used in furnace brazing must have good dimensional stability and generally low thermal mass (to facilitate rapid cooling). Metallic fixtures are limited in their ability to maintain close tolerances through repeated thermal cycles, and are relatively high in thermal mass. Accordingly, graphite and ceramic fixture materials

are normally better suited for use in high-temperature furnace brazing applications. Graphite has been widely used in vacuum and inert gas furnace brazing, and provides excellent results. Ceramics are also used, but typically for smaller fixtures. CAUTION: Graphite should not be used for fixturing in hydrogen furnace brazing without a suitable protective coating, as it will react with the hydrogen and possibly produce carburization of the parts being brazed.

## BRAZING (CON'T.)

### PROTECTIVE FURNACE ENVIRONMENTS

Control of furnace environment is very important to the success of brazing operations. If oxide films form on the base metal surfaces being brazed, the molten braze metal will not wet these surfaces, and a poor braze joint will result. Appropriate cleaning and handling of these base metal surfaces prior to brazing is not enough to ensure success. Exclusion of oxygen, oxidizing gas species, and reducible oxide compounds from the furnace environment during brazing is required.

Oxygen derived from any source within the furnace can produce surface contamination in the joint area. While the

application of vacuum or hydrogen environments may reduce some oxide surface contamination to bare metal, in most cases stable oxides such as those involving aluminum, silicon and even chromium will not be adequately removed. For this reason, use of such environments is also not a substitute for proper cleaning procedures prior to brazing.

Important steps necessary to ensure that proper furnace environment is maintained during brazing are:

- Use only high quality vacuum, inert gas, or hydrogen furnace equipment,

- Make sure outside atmosphere leakage rates are as low as possible,
- For inert gas or hydrogen furnaces, use only high-purity, low-dew-point gas,
- Make sure the interior of the furnace and fixtures are clean, and free of any type of reducible oxide deposits,
- Use proper cleaning techniques on the entire component assembly prior to brazing, not just the surfaces being brazed.

### EFFECTS OF BRAZING CYCLES UPON BASE METAL PROPERTIES

As described in the HEAT TREATMENT section of this guide, thermal exposure at temperatures below the solution treatment temperature range can have effects upon the structure and properties of HAYNES® and HASTELLOY® high-temperature alloys. In brazing, such an exposure can take the form of both time at a selected brazing temperature, and the time taken to heat and cool from that temperature. For brazing operations performed at temperatures below the solution treating range, carbide precipitation, and sometimes other secondary phase precipitation can be expected to occur. As previously discussed, these structural

changes can have negative effects upon alloy properties.

Where brazing is performed at temperatures in the solution treatment temperature range, the issues of normal and abnormal grain growth both arise. As discussed in the HEAT TREATMENT section, selection of the solution treatment temperature (brazing temperature) can have a significant effect upon final component grain size, depending upon the amount of cold strain present in the base metal. In addition, cooling from the brazing temperature, particularly in vacuum furnace brazing, is usually too slow to prevent carbide precipitation in these alloys, with the same negative

effects mentioned above. This is often true even when forced gas cooling is employed.

One additional concern relative to the base material is that of braze metal spatter. Every effort should be made to confine the braze metal to the joint area. Most of the brazing filler metals used will severely degrade the environment resistance of base materials when spattered upon non-joint surfaces. This is particularly critical if spatter should occur upon surfaces outside the joint area which are subjected to service temperatures above the braze metal melting point.

## DESCALING AND PICKLING

Because of their inherent corrosion resistance, HAYNES® and HASTELLOY® high-temperature alloys are relatively inert to cold acid pickling solutions. After heat treatment, the oxide film is more adherent than that of stainless steels. Molten caustic baths followed by acid pickling are the most effective method to remove heat treat related oxide scales. Baths of VIRGO descaling salt, sodium hydride (DuPont) or DGS oxidizing salt have been used for the initial descaling procedure, while the acid pickle is typically a nitric-hydrofluoric solution.

The compositions of the pickling solutions are listed in Table 21. Procedures for descaling and pickling are outlined in Table 22.

Sand, shot, or vapor blasting are acceptable for removing scale under certain conditions. The blasting materials should be such that it provides for a rapid cutting action rather than smearing the surface. Sand should not be reused especially if contaminated with iron. After blasting, it is desirable to give

the part an acid pickle to remove any imbedded iron or other impurities. Extreme care should be taken when sand blasting thin-gage parts because of the danger of distortion and of embedding sand or scale in the metal surface. Sand blasting also tends to work harden the surface of the material and may cause forming problems for certain alloys.

TABLE 21 - Composition of Pickling Solutions

Composition of Pickling Solution, Percent by Weight			
Descaling Method	Sulfuric-Hydrochloric Acid Bath	Permanganate-Sodium Hydroxide Bath	Nitric-Hydrofluoric Acid Bath
VIRGO Descaling Salt Bath	15-17% sulfuric acid 0.5-1.0% hydrochloric acid	Not used	7-8% nitric acid 3-4% hydrofluoric acid
Sodium Hydride Process	Not used	4-6% potassium permanganate 1-2% sodium hydroxide	8-12% nitric acid 2-3% hydrofluoric acid
DGS (Oxidizing Salt Bath) Process	Not used	Not used	15-25% nitric acid 3-5% hydrofluoric acid



## DESCALING AND PICKLING (CON'T.)

TABLE 22 - Descaling and Pickling Procedures

Procedures	Virgo Salt Bath Process	Sodium Hydride Reducing Salt Bath Process	DGS Oxidizing Salt Bath Process
Descaling Bath	Virgo Salt	Sodium Hydride	DGS Salt
Bath Temperature, °F (°C)	970 (520)	750-800 (400-425)	850-950 (455-510)
Descaling Time, Min.	1-3	15	2-10
Water Rinse Time, Min.	1-2	1-2	1-5
Pickling Step 1	Sulfuric-Hydrochloric 165°F (74°C) 3 minutes*	Permanganate-Sodium Hydroxide 135-155°F (57-68°C) 15 minutes*	Nitric-Hydrofluoric 130-150°F (54-66°C) 10-20 minutes
Step 2	Nitric-Hydrofluoric 125-160°F (52-71°C) 25 minutes	Nitric-Hydrofluoric 125-160°F (52-71°C) 15 minutes	None
Final Water Rinse	3 minutes or steam spray	Dip	Dip and steam spray

\*Followed by a water rinse

# MACHINING

HAYNES® and HASTELLOY® high-temperature alloys are classified as moderate to difficult materials to machine; however, it should be emphasized that these alloys can be machined using conventional production methods at satisfactory rates. During machining, these alloys work harden rapidly, generate high heat during cutting, weld to the cutting tool surface, and offer high resistance to metal removal because of their high shear strengths. The following are key points which should be considered during machining operations:

- **CAPACITY** - Machine should be rigid and overpowered as much as possible.
- **RIGIDITY** - Work piece and tool should be held rigid. Minimize tool overhang.
- **TOOL SHARPNESS** - Make sure tools are sharp at all times. Change to sharpened tools at regular intervals rather than out of necessity. A 0.015 inch (0.4 mm) wear land is considered a dull tool.
- **TOOLS** - Use positive rake angle tools for most machine operations. Negative rake angle tools can be considered for intermittent cuts and heavy stock removal. Carbide-tipped tools are suggested for most applications. High speed tools can be used, with lower production rates, and are often recommended for intermittent cuts.
- **POSITIVE CUTS** - Use heavy, constant feeds to maintain positive cutting action. If feed slows and the tool dwells in the cut, work hardening occurs, tool life deteriorates and close tolerances are impossible.
- **LUBRICATION** - Lubricants are desirable. Soluble oils are recommended, especially when using carbide tooling.

Machining parameters for these alloys will vary with the individual materials, but can be grouped by alloy as given in Table 23. Detailed machining information is presented in Table 24.

**TABLE 23 - Alloy Machining Characteristic Groups**

**Group A (Nickel- and Iron-Based)\***

HASTELLOY B alloy  
 HASTELLOY S alloy  
 HASTELLOY W alloy  
 HASTELLOY X alloy  
 HAYNES 75 alloy  
 HAYNES 230® alloy  
 HAYNES 625 alloy  
 HAYNES HR-160® alloy  
 HAYNES HR-120® alloy  
 HAYNES 556 alloy  
 MULTIMET® alloy

**Group B (Cobalt-Based)\*\***

HAYNES 25 alloy  
 HAYNES 188 alloy

\* Age-hardenable nickel based alloys, if machined in the solution annealed condition prior to age hardening heat treatment will have machining characteristics similar to Group A material.

\*\* HAYNES 6B is more difficult to machine than these alloys. Please contact Haynes International for further information.

# MACHINING (CON'T.)

TABLE 24 - Recommended Tools and Machining Parameters

Operations	Recommended Tool Types	Tool Geometry and Set-up**
Roughing, with severe interruptions; Turning or Facing	Carbide: C-2 or C-3 grade	Negative rake square insert, 45° SCEA <sup>1</sup> , 1/32 in. nose radius. Tool holder: 5° negative back rake, 5° negative side rake
Normal roughing; Turning or Facing	Same as above	Same as above
Finishing; Turning or Facing	Same as above	Positive rake square insert, if possible, 45° SCEA, 1/32 in. nose radius. Tool holder: 5° positive back and side rake.
Rough Boring	Same as above	If insert-type boring bar, use standard positive rake tools with largest possible SCEA and 1/16 in. nose radius. If brazed tool bar, grind 0° back rake, 10° positive side rake, 1/32 in. nose radius and largest possible SCEA
Finish Boring	Same as above	Use standard positive rake tools on insert-type bars. Grind brazed bars as for finish turning, except back rake may be best at 0°.
Face Milling	High speed steel: M-2, M-7 or M-40 series <sup>6</sup>	Radial and axial rake 0° to 10° positive, 45° corner angle, 10° relief angle.
	Carbide: C-2 grade (Marginal performance)	Use positive axial and radial rake, 45° corner angle, 10° relief angle.
End Milling	High speed steel: M-40 series or T-15	If possible, use short mills with four or more flutes for rigidity.
	Carbide: C-2 grade	Not recommended but may be successful on good set-ups.

# MACHINING (CON'T.)

Speed	Feed	Depth of Cut	Lubricant
Surface Feet Per Minute*	Inch**	Inch**	
30-50 for group A and group B alloys	0.004-0.008 per revolution	0.150	Dry <sup>2</sup> , oil <sup>3</sup> , or water-base <sup>4,7</sup>
90 for group A and 80 for group B alloys <sup>5</sup>	0.010 per revolution	0.150	Dry, oil, or water-base
95-110 for group A and 90 for group B alloys	0.005-0.007 per revolution	0.040	Dry or water-base
70 for group A and 60 for group B alloys <sup>5</sup>	0.005-0.008 per revolution	0.125	Dry, oil, or water-base
95-110 for group A and 90 for group B alloys	0.002-0.004 per revolution	0.040	Water-base
20-30 for group A and 20-25 for group B alloys	0.003-0.005 per tooth for group A and group B alloys		Oil or water-base
50-60 for group A and 35-40 for group B alloys	0.005-0.008 per tooth for group A and 0.005 per tooth for group B alloys		Oil or water-base
20-25 for group A and 15-20 for group B alloys	Feed per tooth: Diameter    Group A    Group B		Oil or water-base
	1/4 in.    0.002    0.001		
	1/2 in.    0.002    0.0015		
	3/4 in.    0.003    0.002		
	1 in.    0.004    0.003		
50-60 for group A and 40-50 for group B alloys	Same as above		Oil or water-base

\* To convert to surface meters per minute, multiply by 0.30.

\*\* To convert from inches to millimeters, multiply by 25.4.

# MACHINING (CON'T.)

TABLE 24 - Recommended Tools and Machining Parameters (Con't.)

Operations	Recommended Tool Types	Tool Geometry and Set-up
Drilling	High Speed Steel: M-33, M-40 Series, or T-15	Use short, heavy-web drills with 135° crank shaft point. Thinning of web at point may reduce thrust and aid chip control.
	Carbide: C-2 grade	Not recommended, but tipped drills may be successful on rigid set-ups if depth is not great. The web must be thinned to reduce thrust. Use 135° included angle on point. Gun drill can be used.
Reaming	High Speed Steel: M-33, M-40 Series, or T-15	Use 45° corner angle, narrow primary land, and 10° relief angle.
	Carbide: C-2 or C-3 grade	Tipped reamers recommended; solid carbide reamers require very good set-up. Tool geometry same as above.
Tapping	High Speed Steel: M-1, M-7, M-10	Use two flute, spiral point, plug tap 0° to 10° hook angles. Nitrided surface may be helpful by increasing wear resistance, but may result in chipping or breakage. Tap drill for 60-65% thread, if possible, to increase tool life.
	Carbide:	Not recommended
Electrical Discharge Machining	HAYNES® and HASTELLOY® alloys can be readily cut using any conventional electrical discharge machining system (EDM) or wire EDM.	

# MACHINING (CON'T.)

Speed Surface Feet Per Minute*	Feed		Lubricant
	Inch**		
10-15 for group A and 7-10 for group B alloys	Feed per revolution: Diameter    Group A & B		Oil or water-base. Use coolant feed drills if possible.
	1/8 in.	0.001	
	1/4 in.	0.002	
Maximum 200 rpm for 1/4" diameter or smaller drills	1/2 in.	0.003	
	3/4 in.	0.005	
	1 in.	0.007	
50 for group A and 40 for group B alloys	Same as above		Oil or water-base. Coolant-fed carbide tipped drills may be economical in some set-ups.
10-15 for group A and 8 for group B alloys	Feed per revolution: Diameter    Group A & B		Oil or water-base
	1/2 in.	0.003	
	2 in.	0.008	
40 for group A and 20 for group B alloys	Same as above		Oil or water-base
7 for group A and group B alloys	-		Use best possible tapping compound; sulfochlorinated oil-base preferred.

\* To convert to surface meters per minute, multiply by 0.30.

\*\* To convert from inches to millimeters, multiply by 25.4.

Notes: <sup>1</sup> SCEA - Side cutting edge angle, or lead angle of the tool.

<sup>2</sup> At any point where dry cutting is recommended, an air jet directed on the tool may provide substantial tool life increases. A water-base coolant mist may also be effective.

<sup>3</sup> Oil coolant should be a premium quality, sulfochlorinated oil with extreme pressure additives. A viscosity at 100°F of from 50 to 125 SSU is standard.

<sup>4</sup> Water-base coolant should be a 15:1 mix of water with either a premium quality, sulfochlorinated water soluble oil or a chemical emulsion with extreme pressure additives.

<sup>5</sup> Depending upon the rigidity of the set-up.

<sup>6</sup> M-40 series High Speed Steels include M-41 through M-46 at time of writing, others may be added, and should be equally suitable.

<sup>7</sup> Water-base coolants may cause chipping or rapid failure of carbide tools in interrupted cuts.

# GRINDING

When very close tolerances are required, grinding is recommended for finishing HAYNES® and HASTELLOY® high-

temperature alloys. A list of recommended wheels and coolants is presented in Table 25.

**TABLE 25 - Recommended Grinding Wheels and Coolants**

Type of Grinding	Wheels*	Manufacturer	Type of Work	Coolant
<b>Cylinder Grinding</b>				
Straight or Tapered O.D.'s	53A80-J8V127	Norton	Sharp corners and fine finish	Heavy duty soluble coolant 25:1 mix CASTROL 653
Form Work, Single Wheel Section Method	38A60-J8-VBE	Norton	Removing stock Sharp corner work Straight radius work	Dry
Form Work, Crush-Roll Method	53A220-L9VB	Norton	Precision forms Radius	Straight oil
Centerless	53A80-J8VCN	Norton	Thin-walled material Solid or heavy-walled material	Heavy duty soluble coolant 25:1 mix CASTROL 653
<b>Internal Grinding</b>				
Straight or Tapered	23A54-L8VBE	Norton	Small holes Medium-size holes Large holes Small counterbores	Heavy duty soluble coolant 25:1 mix CASTROL 709
<b>Surface Grinding</b>				
Straight Wheel	32A46-H8VBE 38A46-I-V	Norton Norton		Dry or any heavy duty soluble coolant 25:1 mix CASTROL 653
Double Opposed Disk Type	87A46-G12-BV 87A46-J11-BW	Gardner Gardner	Through-feed work Ferris wheel work Thin work	Heavy duty soluble coolant 10:1 mix CASTROL 653
Cylinder or Segmental Type	32A46-F12VBE	Norton	Thin work, bevels and close tolerance work	Sal-soda in water CASTROL 653
Single Wheel Section Method	32A46-F12VBEP	Norton	Profile work	Dry
<b>Thread Grinding</b>				
External Threads	A100-T9BH	Norton		VANTOL 5299-M or equivalent
<b>Honing</b>				
Internal	C120-E12-V32 C220-K4VE J45-J57	Bay State Carborundum Sunnen		VANTOL 5299-C or equivalent
<b>Rough Grinding</b>				
Cut-off (Wet)	86A461-LB25W	Norton		CASTROL 653
Cut-off (Dry)	4NZA24-TB65N	Norton		Dry
Snagging	4ZF1634-Q5B38	Norton		Dry

\*The wheels indicated have been optimized for speeds between 6000 and 6500 sfpm.

# APPENDIX I: COLD WORK AND ANNEAL DATA

TABLE I-1  
Effect of Cold Work and Anneal Cycles Upon the Room  
Temperature Properties of HAYNES® 25 alloy Sheet

Cold Reduction %	5-Minute Subsequent Anneal*	Ultimate Tensile Strength		Yield Strength at 0.2% Offset		Elongation %	Hardness
		Ksi	MPa	Ksi	MPa		
None	None	144	995	68	470	58	Rc24
10	None	182	1255	124	850	37	Rc36
15		178	1230	149	1025	28	Rc40
20		193	1335	151	1040	18	Rc42
25		232	1605	184	1270	15	Rc44
10		163	1125	98	675	39	Rc32
15	1950°F (1065°C)	167	1150	91	630	44	Rc30
20		171	1175	96	665	41	Rc32
25		169	1170	89	615	44	Rc32
10	2050°F (1120°C)	157	1080	74	510	53	Rc27
15		161	1110	79	540	52	Rc28
20		165	1135	82	565	48	Rc31
25		166	1140	83	570	48	Rc30
10	2150°F (1175°C)	148	1020	67	460	63	Rc21
15		156	1075	74	505	55	Rc26
20		154	1060	72	495	59	Rc26
25		149	1030	69	470	62	Rc25
10	2250°F (1230°C)	144	990	69	480	64	Rb95
15		142	975	64	440	68	Rb97
20		135	930	62	425	69	Rb97
25		138	950	61	420	70	Rb96

Tensile results are averages of two or more tests. \*Rapid Air Cool



# APPENDIX I: (CON'T.)

TABLE I-2  
Effect of Cold Work and Anneal Cycles Upon the Room  
Temperature Properties of HAYNES® 188 alloy Sheet

Cold Reduction %	5-Minute Subsequent Anneal*	Ultimate Tensile Strength		Yield Strength at 0.2% Offset		Elongation %	Hardness
		Ksi	MPa	Ksi	MPa		
None	None	137	945	67	460	54	Rb98
10	None	151	1045	106	730	45	Rc32
20		166	1145	133	915	28	Rc37
30		195	1345	167	1150	13	Rc41
40		215	1480	177	1220	10	Rc44
10	1950°F (1065°C)	149	1025	91	630	41	Rc30
20		153	1055	88	605	41	Rc28
30		158	1090	84	580	41	Rc30
40		163	1120	91	625	40	Rc31
10	2050°F (1120°C)	143	985	65	445	50	Rc22
20		149	1025	71	490	47	Rc25
30		155	1070	80	555	44	Rc28
40		159	1095	87	600	43	Rc30
10	2150°F (1175°C)	140	965	62	425	55	Rb96
20		141	975	65	445	53	Rb97
30		143	985	67	460	52	Rb99
40		141	975	64	440	56	Rb97
10	2250°F (1230°C)	132	910	59	410	59	Rb95
20		130	900	58	400	63	Rb94
30		131	900	58	400	63	Rb93
40		132	905	58	400	62	Rb93

Tensile results are averages of two or more tests. \*Rapid Air Cool

# APPENDIX I: (CON'T.)

TABLE I-3  
Effect of Cold Work and Anneal Cycles Upon the Room  
Temperature Properties of HAYNES® 230® alloy Sheet

Cold Reduction %	5-Minute Subsequent Anneal*	Ultimate Tensile Strength		Yield Strength at 0.2% Offset		Elongation %	Hardness
		Ksi	MPa	Ksi	MPa		
None	None	128	885	62	425	47	Rb95
10	None	145	995	104	715	32	Rc28
20		164	1130	133	920	17	Rc35
30		188	1295	160	1105	10	Rc39
40		202	1390	172	1190	8	Rc40
50		215	1480	185	1275	6	Rc42
10	1950°F (1065°C)	144	990	92	635	33	Rc24
20		142	980	81	555	36	Rc26
30		142	980	76	525	36	Rb99
40		146	1005	81	560	32	Rc23
50		148	1020	86	595	35	Rc24
10	2050°F (1120°C)	139	960	81	555	37	Rb98
20		136	935	65	450	39	Rb97
30		140	965	72	495	38	Rb99
40		142	980	76	525	36	Rb99
50		144	990	81	555	36	Rc23
10	2150°F (1175°C)	130	895	56	385	44	Rb92
20		134	925	64	445	40	Rb96
30		138	950	70	485	39	Rb98
40		139	960	73	505	38	Rb98
50		138	950	72	495	39	Rb98
10	2250°F (1230°C)	125	860	52	360	47	Rb92
20		128	885	57	390	45	Rb92
30		126	870	54	370	48	Rb92
40		126	870	53	370	47	Rb91
50		128	880	55	375	46	Rb89

Tensile results are averages of two or more tests. \*Rapid Air Cool

# APPENDIX I: (CON'T.)

TABLE I-4  
Effect of Cold Work and Anneal Cycles Upon the Room  
Temperature Properties of HAYNES® 556™ alloy Sheet

Cold Reduction %	5-Minute Subsequent Anneal*	Ultimate Tensile Strength		Yield Strength at 0.2% Offset		Elongation %	Hardness
		Ksi	MPa	Ksi	MPa		
None	None	115	795	53	365	51	Rb88
10	None	128	880	93	645	35	Rc25
20		142	980	113	780	24	Rc32
30		173	1190	144	995	12	Rc39
40		189	1305	156	1075	10	Rc41
50		204	1410	170	1170	8	Rc42
10	1850°F (1010°C)	122	840	77	530	34	Rb99
20		127	875	89	610	30	Rc25
30		135	930	93	640	27	Rc25
40		133	920	80	550	31	Rc25
50		135	930	83	570	32	Rc25
10	1950°F (1065°C)	122	845	77	530	37	Rb98
20		125	860	77	530	35	Rc23
30		125	865	66	455	38	Rb97
40		128	885	71	490	37	Rc23
50		131	905	78	535	33	Rc23
10	2050°F (1120°C)	117	810	55	380	48	Rb93
20		120	830	58	405	45	Rb92
30		124	850	64	440	43	Rb96
40		125	860	67	460	42	Rb97
50		127	875	71	485	35	Rb98
10	2150°F (1175°C)	_____	_____	Not Available		_____	Rb89
20		_____	_____	Not Available		_____	Rb89
30		_____	_____	Not Available		_____	Rb89
40		_____	_____	Not Available		_____	Rb88
50		_____	_____	Not Available		_____	Rb89

Tensile results are averages of two or more tests. \*Rapid Air Cool

# APPENDIX I: (CON'T.)

TABLE I-5  
Effect of Cold Work and Anneal Cycles Upon the Room  
Temperature Properties of HAYNES® 625 alloy Sheet

Cold Reduction %	5-Minute Subsequent Anneal*	Ultimate Tensile Strength		Yield Strength at 0.2% Offset		Elongation %	Hardness
		Ksi	MPa	Ksi	MPa		
None	None	133	915	70	480	46	Rb97
10	None	151	1040	113	780	30	Rc32
20		169	1165	140	965	16	Rc37
30		191	1315	162	1115	11	Rc40
40		209	1440	178	1230	8	Rc42
50		223	1540	184	1270	5	Rc45
10	1850°F (1010°C)	134	925	63	435	46	
20		138	950	71	490	44	
30		141	970	78	535	44	
40		141	970	82	565	42	
50		141	975	82	560	42	
10	1950°F (1065°C)	133	915	61	425	46	
20		137	950	71	485	45	
30		140	965	77	530	44	
40		142	975	83	575	42	
50		141	975	82	570	42	
10	2050°F (1120°C)	128	880	58	405	50	
20		135	930	67	460	46	
30		127	875	58	400	52	
40		137	945	72	500	44	
50		130	900	61	420	50	
10	2150°F (1175°C)	122	840	52	360	55	
20		124	850	54	370	55	
30		122	840	53	365	56	
40		122	840	52	360	55	
50		119	825	51	350	58	

Tensile results are averages of two or more tests. \*Rapid Air Cool

# APPENDIX I: (CON'T.)

TABLE I-6  
Effect of Cold Work and Anneal Cycles Upon the Room  
Temperature Properties of HAYNES® HR-120® alloy Sheet

Cold Reduction %	5-Minute Subsequent Anneal*	Ultimate Tensile Strength		Yield Strength at 0.2% Offset		Elongation %	Hardness
		Ksi	MPa	Ksi	MPa		
None	None	113	780	60	415	39	Rb93
10	None	126	870	103	710	26	Rc27
20		144	995	129	890	11	Rc32
30		157	1080	143	985	6	Rc34
40		179	1235	159	1100	6	Rc35
50		186	1280	166	1145	5	Rc36
10	1950°F (1065°C)	109	750	52	360	38	Rb89
20		111	765	55	380	38	Rb92
30		115	795	60	415	38	Rb93
40		117	805	65	450	37	Rb93
50		118	815	67	460	34	Rb93
10	2050°F (1120°C)	108	745	49	340	47	Rb88
20		117	765	53	365	41	Rb90
30		112	770	55	380	40	Rb91
40		114	785	58	400	37	Rb91
50		114	785	59	405	37	Rb89
10	2150°F (1175°C)	109	750	49	340	43	Rb86
20		109	750	50	345	42	Rb87
30		110	760	51	350	43	Rb88
40		111	765	50	345	38	Rb86
50		110	760	50	345	39	Rb82
10	2250°F (1230°C)	106	730	46	315	46	Rb84
20		104	715	44	305	47	Rb80
30		103	710	44	305	48	Rb80
40		104	715	44	305	45	Rb81
50		104	715	44	305	43	Rb83

Tensile results are averages of two or more tests. \*Rapid Air Cool

# APPENDIX I: (CON'T.)

TABLE I-7  
Effect of Cold Work and Anneal Cycles Upon the Room  
Temperature Properties of HAYNES® HR-160® alloy Sheet

Cold Reduction %	5-Minute Subsequent Anneal*	Ultimate Tensile Strength		Yield Strength at 0.2% Offset		Elongation %	Hardness
		Ksi	MPa	Ksi	MPa		
None	None	109	750	50	345	68	Rb88
10	None	119	820	81	555	52	Rc21
20		135	930	112	775	28	Rc30
30		164	1135	145	1000	13	Rc35
40		187	1285	164	1130	9	Rc39
50		201	1385	174	1200	8	Rc41
10	1850°F (1010°C)	_____	_____	Not Available		_____	_____
20		_____	_____			_____	_____
30		_____	_____			_____	_____
40		_____	_____			_____	_____
50		_____	_____			_____	_____
10	1950°F (1065°C)	112	775	47	325	61	
20		117	805	49	335	57	
30		123	850	56	385	51	
40		126	870	61	415	50	
50		129	890	64	445	47	
10	2050°F (1120°C)	106	735	41	285	72	
20		106	735	41	285	68	
30		106	730	41	285	69	
40		102	705	39	270	69	
50		107	735	41	280	65	
10	2150°F (1175°C)	_____	_____	Not Available		_____	_____
20		_____	_____			_____	_____
30		_____	_____			_____	_____
40		_____	_____			_____	_____
50		_____	_____			_____	_____

Tensile results are averages of two or more tests. \*Rapid Air Cool

# APPENDIX I: (CON'T.)

TABLE I-8  
Effect of Cold Work and Anneal Cycles Upon the Room  
Temperature Properties of HASTELLOY® S alloy Sheet

Cold Reduction %	5-Minute Subsequent Anneal*	Ultimate Tensile Strength		Yield Strength at 0.2% Offset		Elongation %	Hardness
		Ksi	MPa	Ksi	MPa		
None	None	134	920	74	510	44	Rb84
10	None	139	960	92	635	38	Rc23
20		163	1125	136	935	17	Rc29
30		181	1250	154	1060	10	Rc33
40		191	1315	166	1145	8	Rc36
50		211	1450	177	1220	7	Rc39
10	1750°F (955°C)	137	945	83	575	41	
20		136	940	70	480	46	
30		140	965	78	535	44	
40		140	960	80	550	41	
50		143	985	86	590	38	
10	1850°F (1010°C)	137	945	81	560	43	
20		137	940	68	470	46	
30		138	950	73	505	47	
40		137	945	73	500	43	
50		138	950	77	530	39	
10	1950°F (1065°C)	126	870	52	360	50	
20		133	915	63	435	47	
30		133	920	65	450	48	
40		133	920	66	455	45	
50		133	915	66	455	41	
10	2050°F (1120°C)	121	835	50	345	54	
20		123	850	54	370	52	
30		124	855	54	375	49	
40		122	840	52	360	51	
50		120	830	51	355	52	

Tensile results are averages of two or more tests. \*Rapid Air Cool

# APPENDIX I: (CON'T.)

TABLE I-9  
Effect of Cold Work and Anneal Cycles Upon the Room  
Temperature Properties of HASTELLOY® X alloy Sheet

Cold Reduction %	5-Minute Subsequent Anneal*	Ultimate Tensile Strength		Yield Strength at 0.2% Offset		Elongation %	Hardness
		Ksi	MPa	Ksi	MPa		
None	None	114	785	57	395	46	Rb89
10	None	129	885	96	665	29	Rc25
20		147	1015	122	840	15	Rc31
30		169	1165	142	980	10	Rc35
40		186	1280	159	1095	8	Rc37
50		200	1380	171	1180	7	Rc39
10	1850°F (1010°C)	125	865	76	525	32	Rb98
20		132	910	91	625	27	Rc23
30		135	930	87	600	28	Rb99
40		133	920	77	535	32	Rb98
50		135	930	81	560	33	Rb99
10	1950°F (1065°C)	122	845	74	510	34	Rb93
20		124	855	66	450	35	Rb96
30		126	865	63	435	36	Rb96
40		129	885	70	485	35	Rb96
50		129	890	74	510	34	Rb97
10	2050°F (1120°C)	119	825	53	365	42	Rb89
20		121	835	56	385	40	Rb91
30		123	850	61	415	39	Rb94
40		125	860	65	450	37	Rb94
50		125	865	67	460	38	Rb94
10	2150°F (1175°C)	109	755	45	315	49	Rb94
20		111	765	47	325	47	Rb87
30		113	775	49	335	46	Rb86
40		110	760	46	320	48	Rb85
50		110	760	46	315	48	Rb84

Tensile results are averages of two or more tests. \*Rapid Air Cool



## APPENDIX II: TYPICAL SPECIFICATIONS<sup>1</sup>

Alloy	UNS No.	Sheet, Strip, & Plate	Bar & Rod	Forgings	ASTM Designations <sup>3</sup>			Wire <sup>2</sup>
					Welded Pipe	Welded Tube	Seamless Tube	
25	R30605	AMS 5537	AMS 5759	AMS 5759	B-619	B-626		AMS 5796
188	R30188	AMS 5608	AMS 5772	AMS 5772				AMS 5801
230 <sup>®</sup>	NO6230	AMS 5878	AMS 5891	AMS 5891	B-619 <sup>3</sup>	B-626 <sup>3</sup>	B-622 <sup>3</sup>	
		B-435 <sup>3</sup>	B-572 <sup>3</sup>	B-564 <sup>3</sup>				
556 <sup>®</sup>	R30556	AMS 5874	AMS 5877	AMS 5877	B-619 <sup>3</sup>	B-626 <sup>3</sup>	B-622 <sup>3</sup>	
		B-435 <sup>3</sup>	B-572					
625	NO6625	AMS 5599	AMS 5666	AMS 5666	B-705 <sup>3</sup>	B-704 <sup>3</sup>	B-444 <sup>3</sup>	AMS 5837
		B-443 <sup>3</sup>	B-446 <sup>3</sup>					
HR-120 <sup>®</sup>	NO8120	AMS 5916						
		B-409 <sup>3</sup>	B-408 <sup>3</sup>	B-564 <sup>3</sup>	B-514 <sup>3</sup>	B-515 <sup>3</sup>	B-407 <sup>3</sup>	
HR-160 <sup>®</sup>	N12160	B-435 <sup>3</sup>	B-572 <sup>3</sup>	B-564 <sup>3</sup>	B-619 <sup>3</sup>	B-626 <sup>3</sup>	B-622 <sup>3</sup>	
S	NO6635	AMS 5873	AMS 5711	AMS 5711				AMS 5838
X	NO6002	AMS 5536	AMS 5754	AMS 5754	B-619 <sup>3</sup>	B-626 <sup>3</sup>	B-622 <sup>3</sup>	AMS 5798
		B-435 <sup>3</sup>	B-572 <sup>3</sup>					

Notes: <sup>1</sup> Not an exhaustive list. Contact Haynes International for more information.

<sup>2</sup> See Table 12, page 24 for more detailed information.

<sup>3</sup> ASTM specification designation. ASME designations use a SB-prefix.

<sup>®</sup> RA85H is a trademark of Rolled Alloys, Inc.

253MA is a trademark of Avesta Jernverks AB

800HT is a trademark of the Inco Family of Companies

# STANDARD PRODUCTS

By Brand or Alloy Designation:

# HAYNES

International

## HASTELLOY® Family of Corrosion-Resistant Alloys

B-3®, C-4, C-22®, C-276, C-2000®, C-22HS®, G-30®, G-35®, G-50®, HYBRID-BC1™, and N

## HASTELLOY Family of Heat-Resistant Alloys

S, W, and X

## HAYNES® Family of Heat-Resistant Alloys

25, R-41, 75, HR-120®, HR-160®, 188, 214®, 230®, 230-W®, 242®, 263, 282®, 556®, 617, 625, 65SQ®, 718, X-750, MULTIMET®, NS-163™, and Waspaloy

## Corrosion-Wear Resistant Alloy

ULTIMET®

## Wear-Resistant Alloy

6B

## HAYNES Titanium Alloy Tubular

Ti-3Al-2.5V

**Standard Forms:** Bar, Billet, Plate, Sheet, Strip, Coils, Seamless or Welded Pipe & Tubing, Pipe Fittings, Flanges, Fittings, Welding Wire, and Coated Electrodes

Properties Data: The data and information in this publication are based on work conducted principally by Haynes International, Inc. and occasionally supplemented by information from the open literature, and are believed to be reliable. However, Haynes does not make any warranty or assume any legal liability or responsibility for its accuracy, completeness, or usefulness, nor does Haynes represent that its use would not infringe upon private rights.

Any suggestions as to uses and applications for specific alloys are opinions only and Haynes International, Inc. makes no warranty of results to be obtained in any particular situation. For specific concentrations of elements present in a particular product and a discussion of the potential health affects thereof, refer to the Material Safety Data Sheet supplied by Haynes International, Inc. All trademarks are owned by Haynes International, Inc.

### Global Headquarters

1020 West Park Avenue

P.O. Box 9013

Kokomo, Indiana 46904-9013 (USA)

Phone: 1-800-354-0806 or (765) 456-6012

Fax: (765) 456-6905

[www.haynesintl.com](http://www.haynesintl.com)